

HDS 5/11 U/UX Service Manual



Contents

1	Preface	4
2	Safety instructions	4
2.1	Hazard levels	4
3	Technical Features	4
3.1	General	4
3.2	Connection performance of appliance	4
3.3	Electrical system	4
3.4	Drive	4
3.5	Pump	4
3.6	Booster heater	4
3.7	Cleaner	4
3.8	Accessories	4
4	Parts of the system	5
4.1	View from the front, appliance with hose drum	5
4.2	View from the front, appliance without hose drum	6
4.3	Rear view	7
4.4	View from below	8
4.5	View from the front left, appliance hood removed	9
4.6	View from the front right, appliance hood removed	10
5	Function	11
5.1	Functional diagram	11
5.2	Power switch	12
5.3	Filter of water supply	12
5.4	Electronics system	13
5.5	Burner blower with fuel pump	14
5.6	Booster heater	16
5.6.1	Remove burner	18
5.7	Burner	19
5.7.1	Disassemble the burner	20
5.8	Hand spray gun and triple nozzle	21
5.8.1	Hand spraygun	21
5.8.2	Triple nozzle	22
5.9	Remove the top part with the on-demand heater	23
5.9.1	Remove high pressure hose (UX version only)	23
5.9.2	Close the fuel lines	23
5.9.3	Disconnect the connections on the burner	24
5.9.4	Disconnect the connections on the pump head	24
5.9.5	Loosen the base plate of the on-demand heater	25
5.9.6	Pull the on-demand heater assembly out toward the top.	25
5.10	Floor group	27
5.10.1	Remove the motor/pump unit	28

5.11	Motor/pump unit	28
5.11.1	View from above	28
5.11.2	Left view	29
5.11.3	Sectional illustration	30
5.11.4	Cross section of pump head front view	31
5.11.5	Single parts, pump head	32
5.11.6	Electric box, motor (open)	33
5.11.7	Remove the ventilator wheel of the burner blower	34
5.11.8	Remove the safety block	34
5.11.9	Safety block, front view	34
5.11.10	Safety block, rear view	34
5.11.11	Safety block, cross section drawing	35
5.11.12	Remove the detergent injector and the pressure holding valve	35
5.11.13	Remove the water inlet	36
5.11.14	Remove the control piston for the pressure switch.	36
5.11.15	Disassemble the pump	37
6	Basic settings and service procedures	39
6.1	Brief overview, dismantling / assembly	39
6.1.1	Upper section	39
6.1.2	Back of appliance	40
6.2	Remove the hose drum	41
6.2.1	Replace the seal of the rotary grommet	42
6.3	Remove the rear wall	43
6.4	Settings, burner	43
6.5	Adjust safety valve	44
7	Circuit diagram 0.089-212	45
8	Troubleshooting	46
9	Technical specifications	47
10	Special tools	48
11	Tightening torques	50
12	Maintenance intervals	50

1 Preface

Good service work requires extensive and practice-oriented training as well as well-structured training materials.

Hence we offer regular basic and advanced training programmes covering the entire product range for all service engineers.

In addition to this, we also prepare service manuals for important appliances - these can be initially used as instruction guides and later on as reference guides.

Apart from this, we also regular information about product enhancements and their servicing.

If you should require supplements, have corrections or questions regarding this document, please address these citing the following subject to:
international-service@de.kaercher.com

Subject:	Fall 108235
----------	--------------------

The responsible product specialist will take care of your issue.

Copying and duplication of texts and diagrams as well as third-party access to this information is permitted only with the explicit permission of the company:

Alfred Kärcher GmbH & Co. KG
P O Box 160
D -71349 Winnenden
www.kaercher.com

2 Safety instructions

2.1 Hazard levels

⚠ Danger

Immediate danger that can cause severe injury or even death.

⚠ Warning

Possible hazardous situation that could lead to severe injury or even death.

Caution

Possible hazardous situation that could lead to mild injury to persons or damage to property.

3 Technical Features

3.1 General

Extremely mobile hot water high pressure cleaners in the introductory class for commercial use with frequently changing work sites.

- High performance burner with upright heating coil and continuous ignition
- Burner blower and fuel pump directly on the electric motor

3.2 Connection performance of appliance

- 2.2 kW

3.3 Electrical system

- Appliance switch with adjustments for cold water/hot water
- Pressure switch

3.4 Drive

- 2-pin air-cooled motor
- Motor with winding protection

3.5 Pump

- 3 piston axial pump with stainless steel piston (diameter=12 mm)
- Cylinder head made of brass
- High pressure valves made of stainless steel
- Suction valves made of plastic
- Swash plate with axial ball bearing
- Pressure holding valve
- Safety block with lack of water fuse
- without pressure gauge
- without pressure and volume control
- Working pressure: 11 MPa (110 bar)
- Water quantity: 450 l/h
- Water filter on water inlet
- Safety valve
- Water supply temperature: max. 30°C

3.6 Booster heater

- Upright heating coil
- Temperature increase approx. 50°C
- Maximum water output temperature: 80°C
- Heating oil consumption: 2.7 kg/h
- Exhaust temperature monitor: 280°C
- Temperature controller 95°C

3.7 Cleaner

- Detergent suction with fine filter from free-standing container
- Detergent suction via injector in vacuum
- Dosing on filter

3.8 Accessories

- Extended hand spray gun
- Stainless steel spray pipe, 550 mm
- 3-fold nozzle
- Hose drum (version UX)
- Option hourmeter (6.681-010) no upgrade kit. In addition, cables and insulated plugs are required. Can be connected as per the circuit diagram and be placed into the electric box after the wire clip is removed.

4 Parts of the system

4.1 View from the front, appliance with hose drum



- 1 Hand spraygun
- 2 Hand lever
- 3 High pressure hose
- 4 Push handle
- 5 Handgun storage clip
- 6 Hose drum
- 7 High pressure line
- 8 Cover
- 9 Spray lance

- 10 Water inlet with water fine filter
- 11 Bearing wheel
- 12 Carrying handle
- 13 High pressure hose output
- 14 Carrying handle
- 15 Power switch
- 16 Exhaust nozzle, on-demand heater
- 17 Crank, hose drum

4.2 View from the front, appliance without hose drum



- | | |
|--------------------------------------|-------------------------------------|
| 1 Hand spraygun | 14 Power switch |
| 2 Hand lever | 15 Exhaust nozzle, on-demand heater |
| 3 High pressure hose | |
| 4 Push handle | |
| 5 Handgun storage clip | |
| 6 Cover | |
| 7 Spray lance | |
| 8 High-pressure outlet | |
| 9 Water inlet with water fine filter | |
| 10 Bearing wheel | |
| 11 Carrying handle | |
| 12 Support leg | |
| 13 Carrying handle | |

4.3 Rear view



- 1 Push handle
- 2 Storage compartment for mains cable
- 3 Power cord with plug
- 4 Lock for fuel tank
- 5 Fill indicators of fuel tank
- 6 Storage for rotor nozzle
- 7 Kick plate to tilt the appliance
- 8 High-pressure outlet
- 9 Water inlet with water fine filter
- 10 Detergent suction and dosing with fine filter
- 11 Back of appliance
- 12 Handgun storage clip

4.4 View from below



- 1 Deflection rollers high pressure hose
- 2 Support leg
- 3 Carrying handle
- 4 Guide for high pressure hose
- 5 High pressure hose
- 6 Axle
- 7 Air suction for motor cooling
- 8 Air suction for burner blower

4.5 View from the front left, appliance hood removed

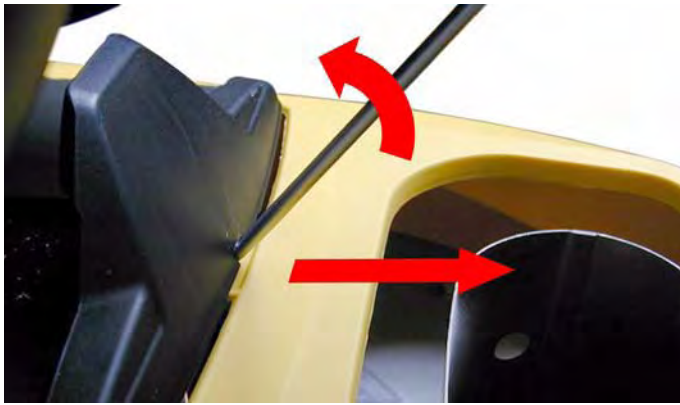

To remove the appliance hood, you must unlock it by means of a screwdriver.

→ Unlock the appliance hood from above using a screwdriver and remove it.



- | | |
|--|---------------------------------------|
| 1 High pressure line | 8 Electric box for high pressure pump |
| 2 Ignition transformer | 9 Electronics system |
| 3 Protective conductor | 10 Continuous heater |
| 4 Burner | 11 Fuel tank |
| 5 Water inlet with water fine filter | 12 Exhaust nozzle, on-demand heater |
| 6 High pressure output (appliance without hose drum) | 13 Fuel line |
| 7 Pump head | |

4.6 View from the front right, appliance hood removed

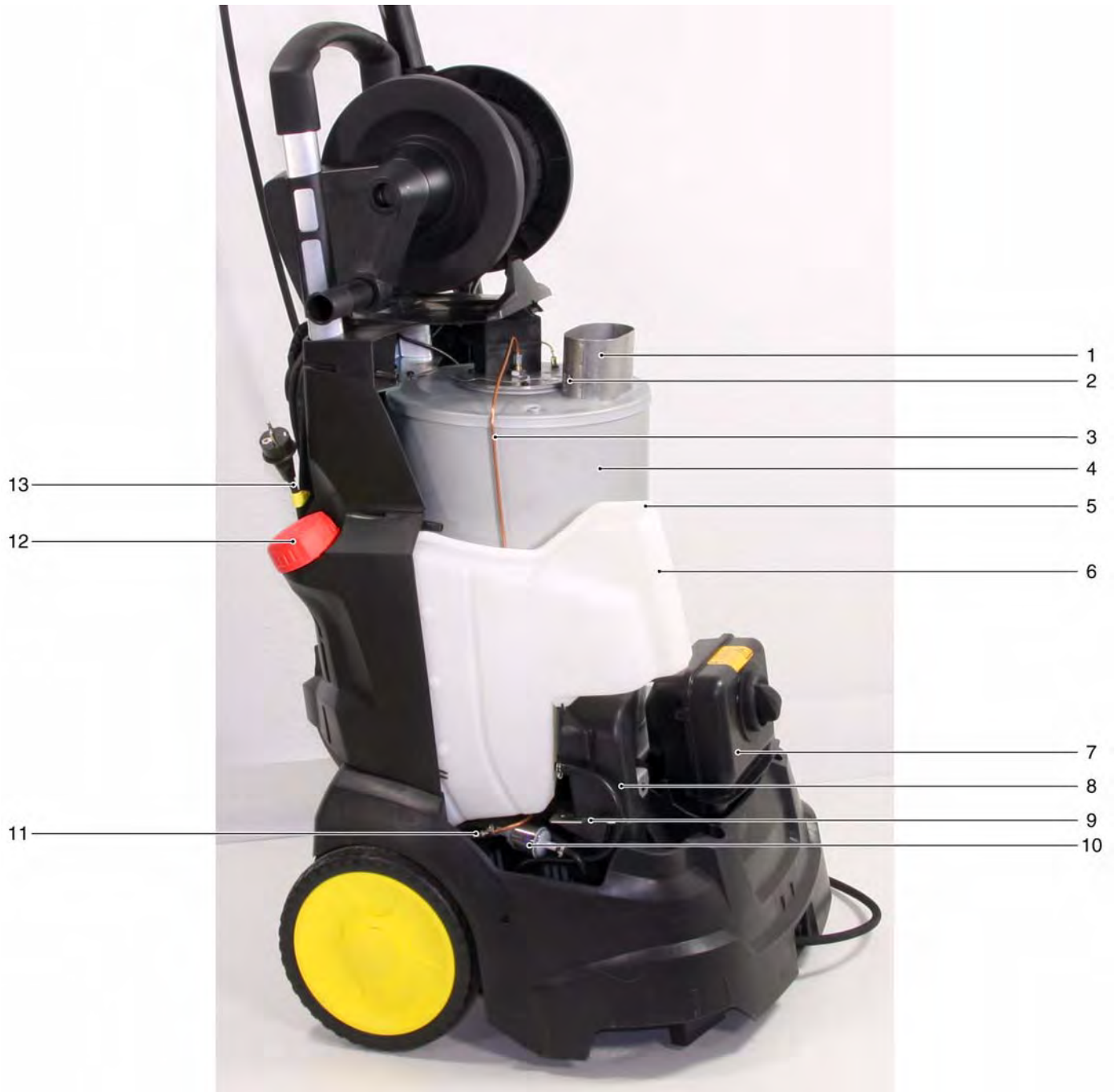

- 1 Exhaust nozzle, on-demand heater
- 2 Exhaust temperature sensor
- 3 Fuel line
- 4 Continuous heater
- 5 Aeration/deaeration of the fuel tank
- 6 Fuel tank
- 7 Electronics system
- 8 Air guidance burner blower
- 9 Air volume setting
- 10 Fuel filter
- 11 Screw connection of fuel line
- 12 Lock for fuel tank
- 13 Power cord with plug

5 Function

5.1 Functional diagram

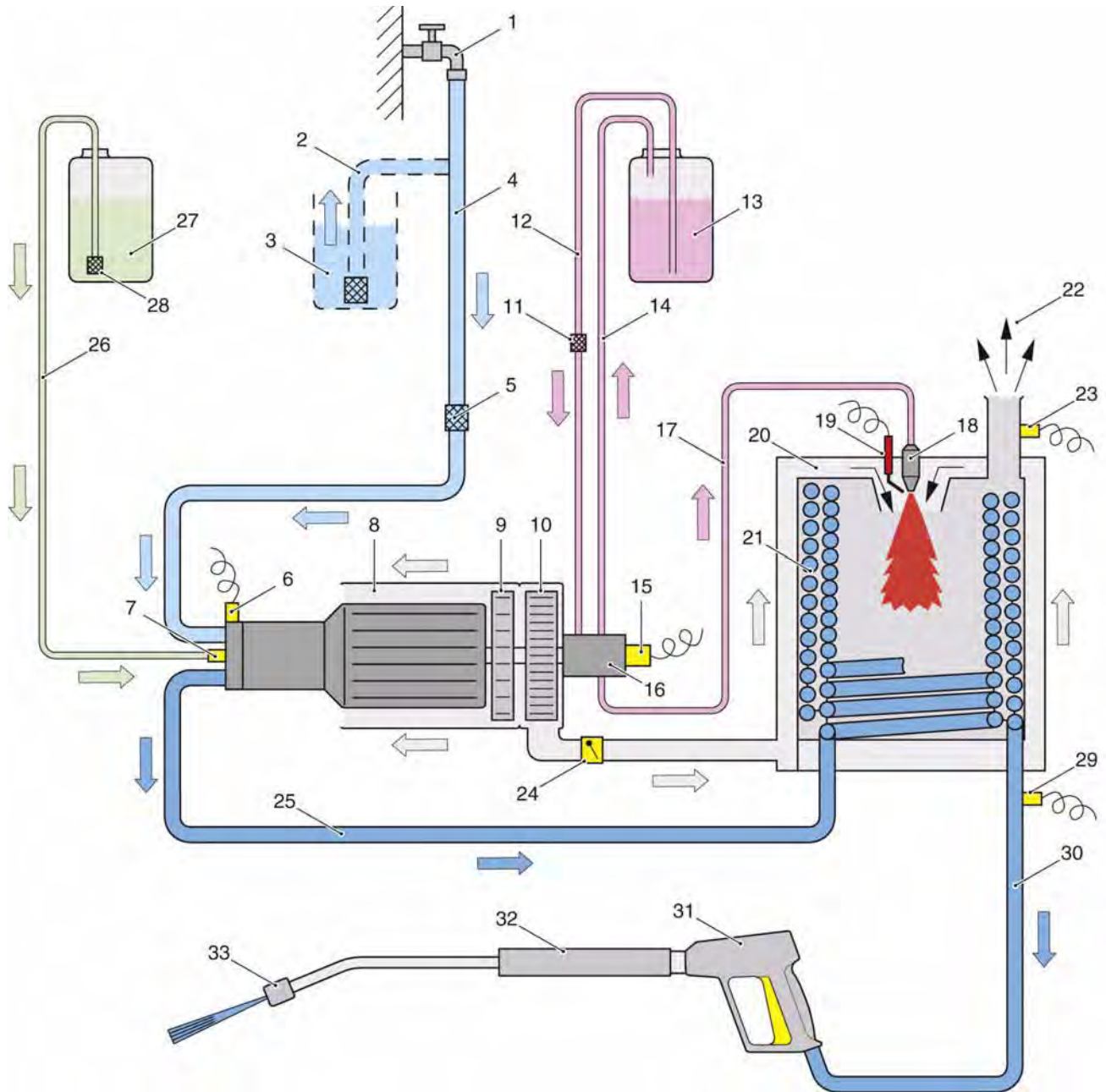

- | | |
|--|---|
| 1 Water connection | 18 Fuel nozzle |
| 2 Suction hose with filter and backflow valve (option) | 19 Ignition electrodes |
| 3 Open container | 20 Continuous heater |
| 4 Water supply hose | 21 Heating coil, on-demand heater |
| 5 Water fine filter | 22 Exhaust nozzle, on-demand heater |
| 6 Pressure switch | 23 Exhaust temperature sensor |
| 7 Detergent injector | 24 Slider, air volume adjustment |
| 8 Cooling air routing | 25 High pressure line to the on-demand heater |
| 9 Ventilator wheel, motor cooling | 26 Detergent hose |
| 10 Ventilator wheel, burner blower | 27 Detergent tank (external) |
| 11 Fuel filter | 28 Filter with dosing |
| 12 Fuel hose supply to the fuel filter | 29 Temperature controller 95°C |
| 13 Fuel tank | 30 High pressure hose |
| 14 Fuel hose return to the fuel tank | 31 Trigger gun |
| 15 Solenoid valve, fuel pump | 32 Spray lance |
| 16 Fuel pump | 33 High pressure nozzle |
| 17 Fuel line to burner | |

5.2 Power switch

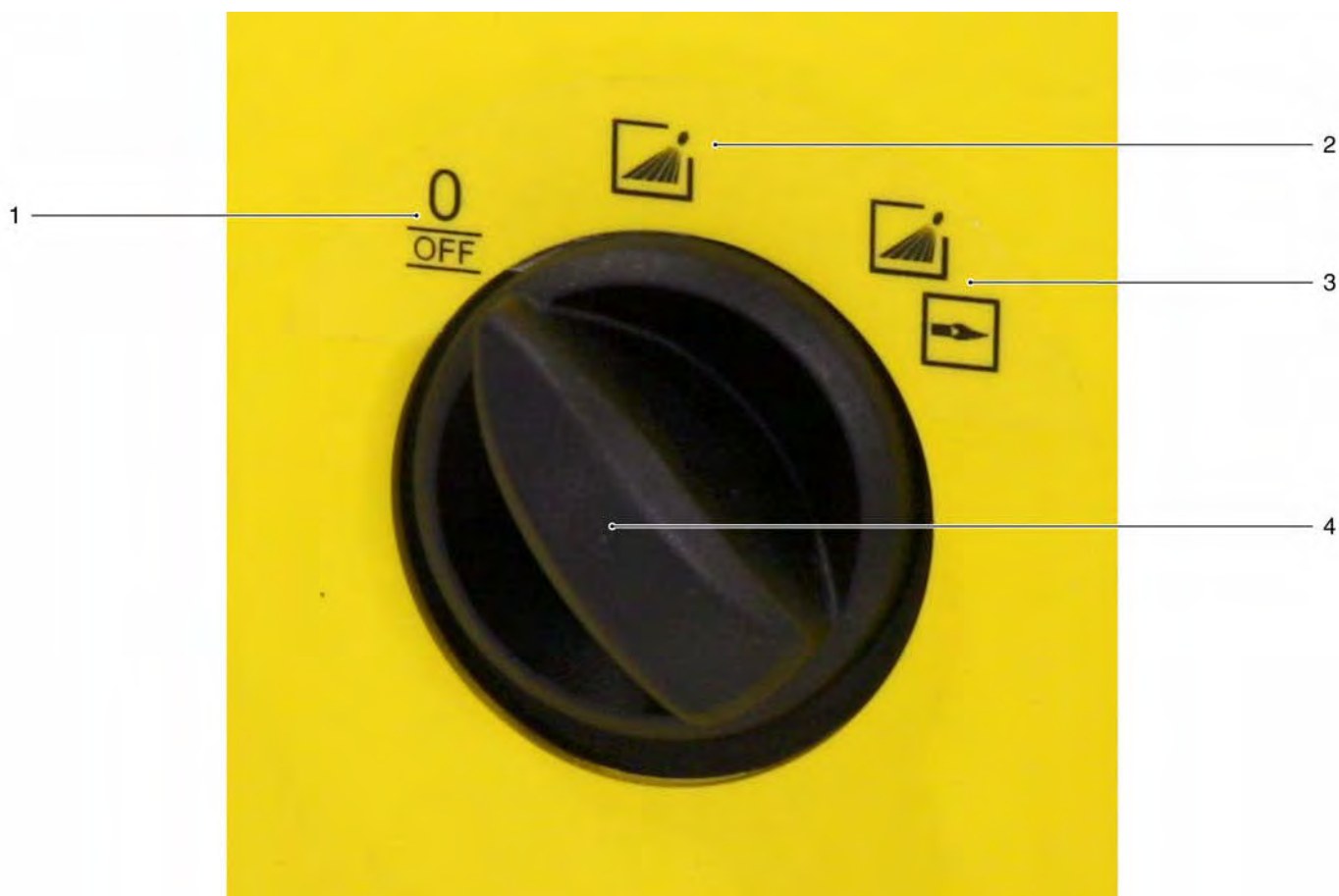

- 1 Switch position "OFF"
 - 2 Switch position "Cold water operation"
 - 3 Switch position "Hot water operation"
 - 4 Power switch
- "OFF": Appliance is switched off
 - "Cold water operation": High pressure cleaner function without on-demand heater
 - "Hot water operation": High pressure cleaner function with on-demand heater

The appliance switch on the front of the appliance has three different switch positions.

5.3 Filter of water supply

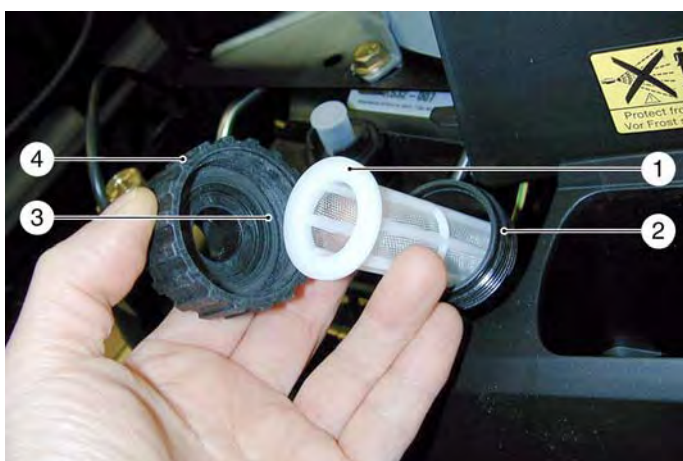

- 1 Water filter
- 2 Pipe of water supply
- 3 Seal
- 4 Lid of water supply

5.4 Electronics system



Open the switchbox

- Lift the electric box out of its holder by alternatingly lifting it toward the top.
- Bend up the four side tabs and remove the top part.

- 1 Electronics system
- 2 Side tabs
- 3 Top part of electric box

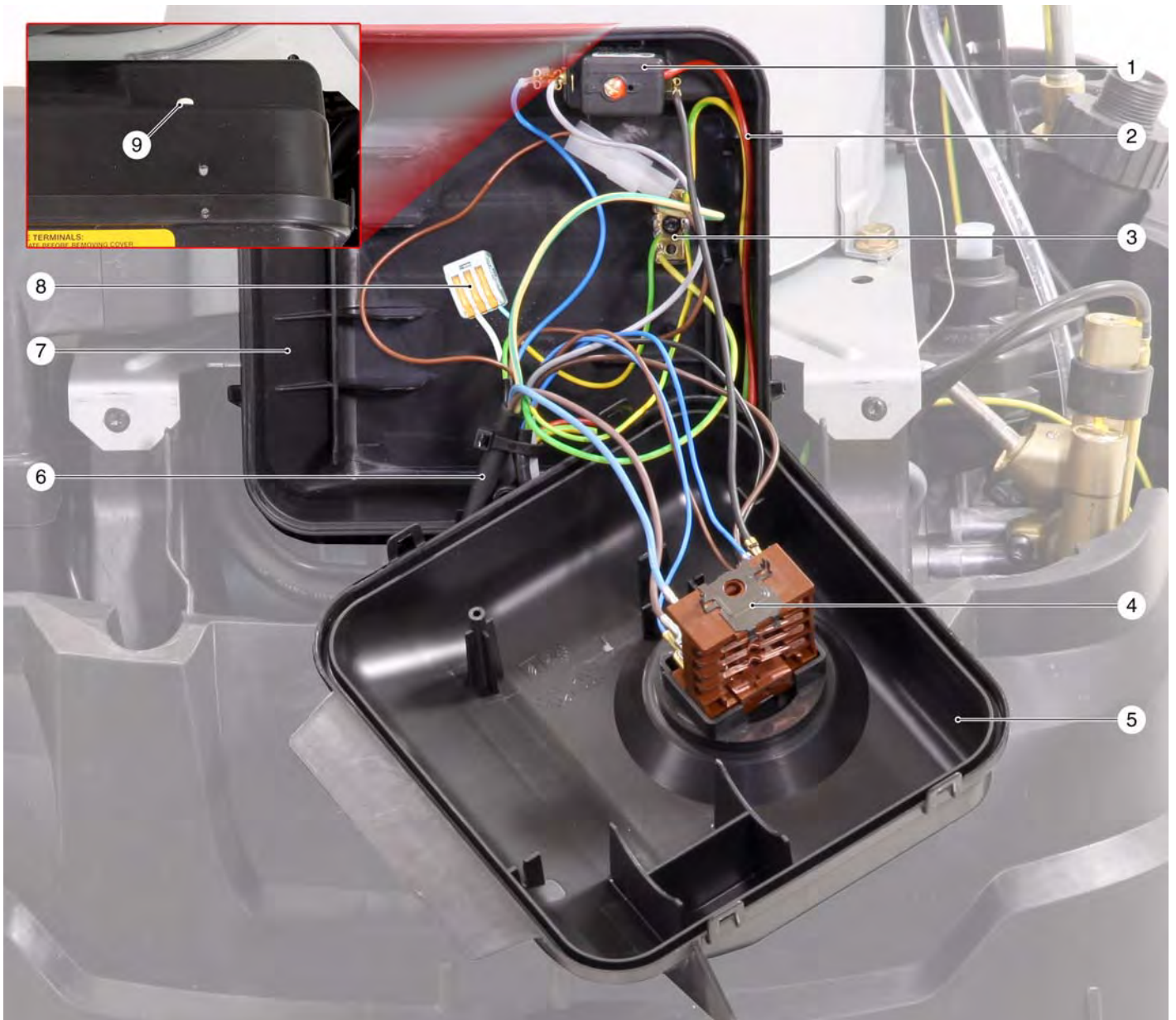

- 1 Exhaust temperature monitor 280°C
- 2 Capillary exhaust temperature monitor
- 3 Terminal strip of protective conductor
- 4 Power switch
- 5 Top part of electric box
- 6 Power cord
- 7 Electronics system
- 8 3-fold clamp, connection of temperature controller 95 °C
- 9 Reset button of exhaust temperature monitor

5.5 Burner blower with fuel pump

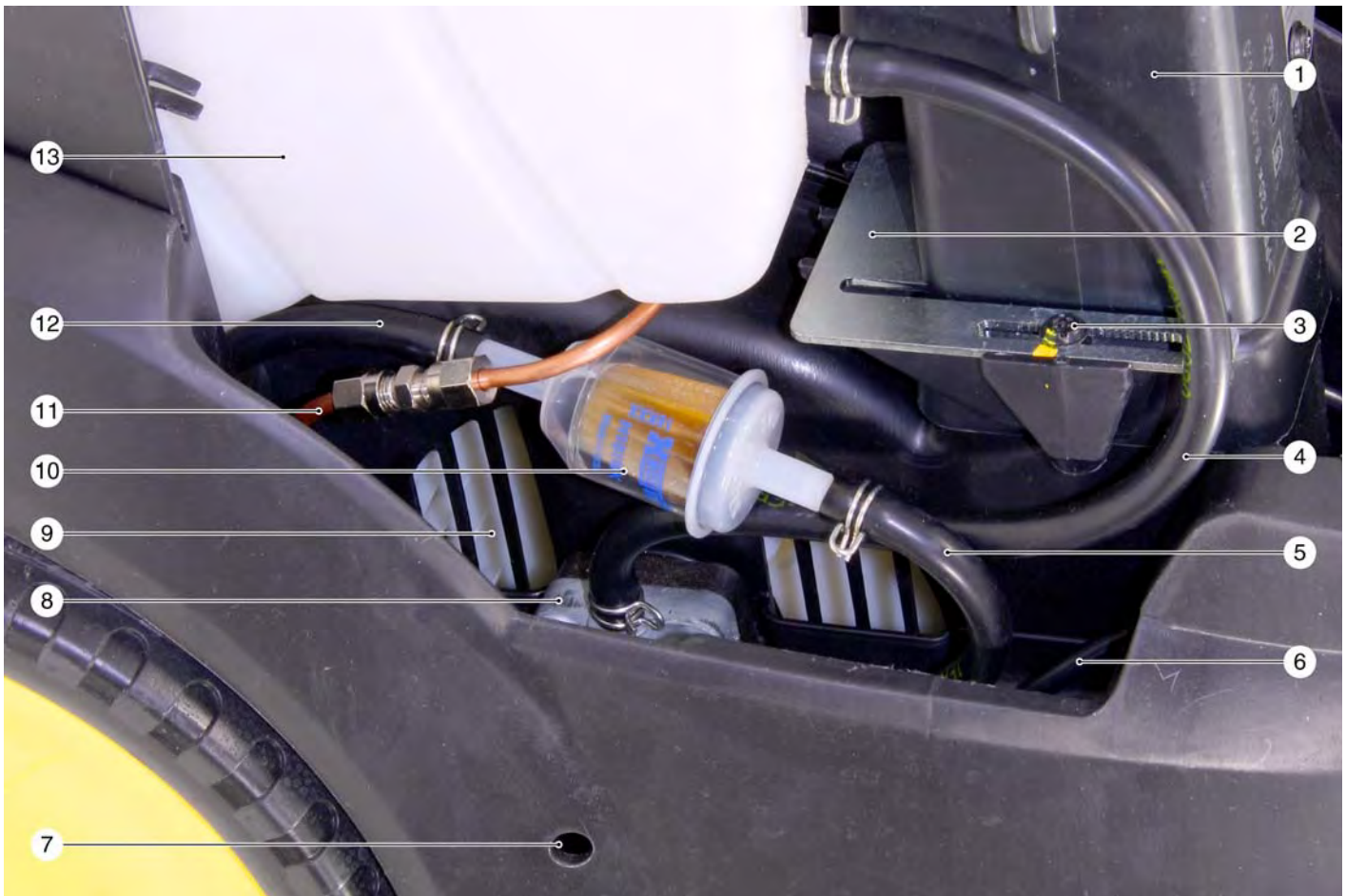

- 1 Air guidance to the on-demand heater
- 2 Slider, air volume adjustment
- 3 Stop screw, air volume adjustment
- 4 Return to fuel tank
- 5 Fuel hose supply to the fuel pump
- 6 Connecting cable of solenoid valve and fuel pump
- 7 Access opening of fuel pressure adjustment
- 8 Fuel pump
- 9 Suction opening, burner blower
- 10 Fuel filter
- 11 Fuel line from fuel pump to burner
- 12 Fuel hose supply to the fuel filter
- 13 Fuel tank

Fuel pump

The fuel pump is connected directly to the motor shaft via the coupling piece and the blower wheel. It also feeds fuel from the tank and back via the return during cold water operation. This lubricates the toothed wheel pump.

During warm water operation, the installed solenoid valve and part of the fuel reaches the burner through the fuel nozzle and is ignited there.

The fuel pressure is adjusted via the central setting screw.

During dry runs, the fuel pump will block.

The coupling piece serves as a nominal breaking point.

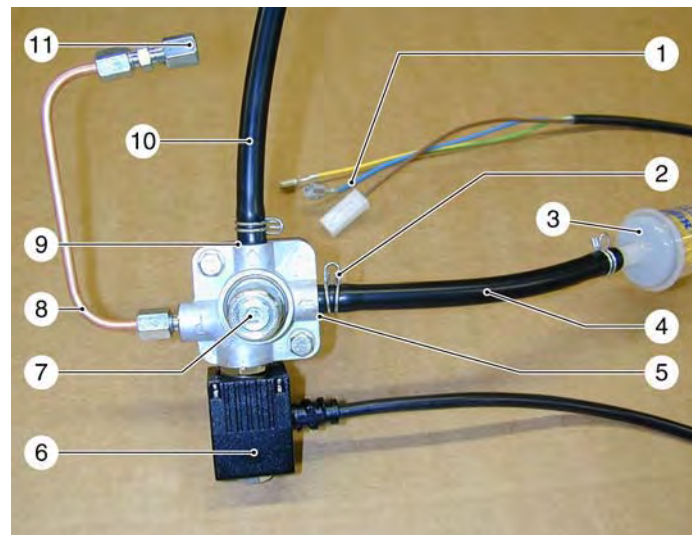

- 1 Cable connections for fuel solenoid valve
- 2 Safety clip
- 3 Fuel filter
- 4 Fuel hose
- 5 Supply
- 6 Fuel solenoid valve 230 V
- 7 Adjustment screw for fuel pressure
- 8 Fuel line to burner nozzle
- 9 Return to fuel tank
- 10 Fuel hose
- 11 Screw connection of fuel line

Burner blower

The blower supplies the burner with combustion air. The slider is used to set the air volume to optimal combustion values. The blower wheel is mounted to the motor shaft by means of a fitting key.



- 1 Stop screw
- 2 Air slider
- 3 Mark to adjust the air slider

5.6 Booster heater

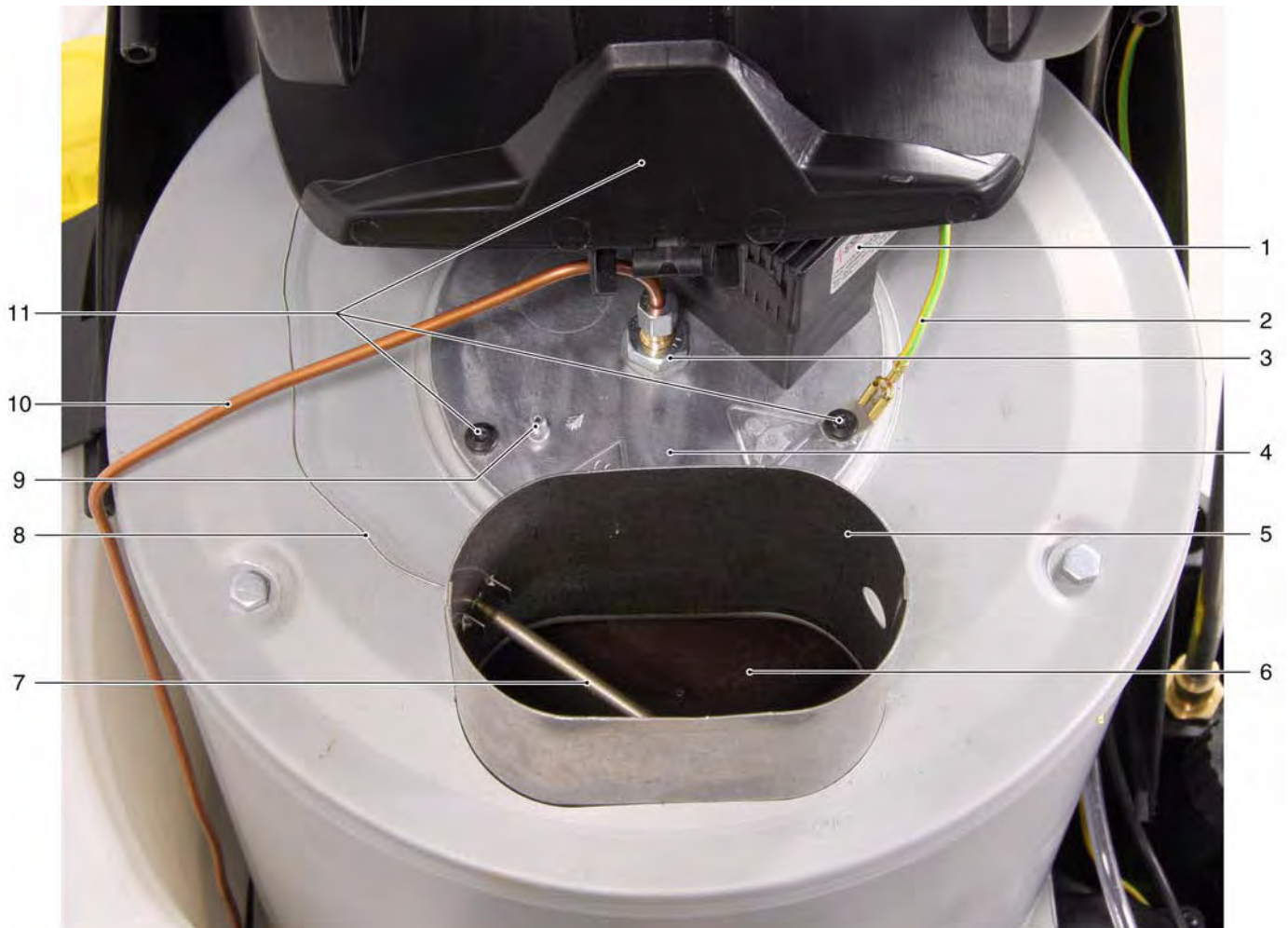

- 1 Ignition transformer
- 2 Protective conductor
- 3 Fuel nozzle holder
- 4 Burner cover
- 5 Exhaust nozzle, on-demand heater
- 6 Heating coil
- 7 Exhaust temperature sensor
- 8 Capillary exhaust temperature monitor
- 9 Connection for air pressure measurement
- 10 Fuel line
- 11 Screws for burner cover (3 x)

Type plate

The type plate of the heating coil can be read through the exhaust stack.



- 1 Year of manufacture
- 2 Specifications
- 3 Part number of heating coil
- 4 Pressure test passed
- 5 Continuous plant number

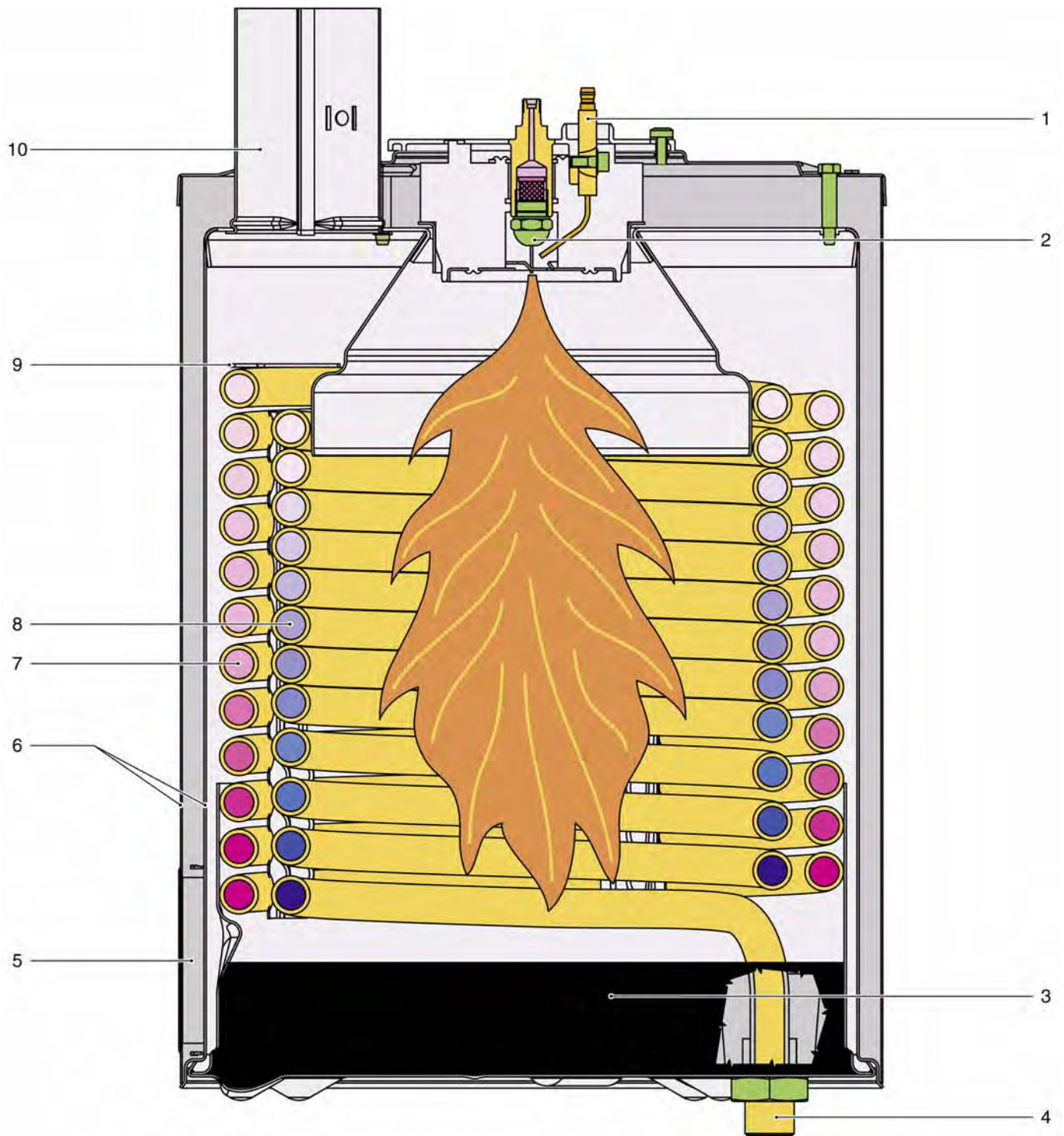

- 1 Ignition electrodes
- 2 Fuel nozzle
- 3 Boiler floor
- 4 Boiler input
- 5 Air supply from burner blower
- 6 Boiler exterior, double-walled
- 7 Heating coil spiral, exterior
- 8 Heating coil spiral, interior
- 9 Type plate of heating coil
- 10 Exhaust nozzle, on-demand heater

The water from the high pressure pump enters the interior heating coil spiral, is heated while flowing through and exits to the bottom from the heating coil spiral.

The fuel is vaporised by the fuel nozzle and ignited by the spark of the ignition electrodes.

The combustion air from the blower first flows through the double-walled boiler exterior toward the top, then it flows downward with the flame and is emitted as exhaust through the exhaust stack toward the top into the atmosphere.

The boiler floor is made of fire-resistant insulating concrete. It prevents a radiation of the heat and is used to reroute the flames.

The adjustment of the burner to good exhaust values is achieved via the air slider on the blower (air volume) and with the adjustment screw on the fuel pump (fuel pressure).

The temperature increase with full water volume is about 50°C. Assuming the max. supply temperature of the water of 30°C, the water can be heated to about 80°C.

An optimal burner performance is only possible if the heating coil is neither full of soot nor other deposits. Furthermore, the spark electrodes, the amount of fuel and the amount of air must be adjusted properly.

5.6.1 Remove burner

In order to remove the burner, three screws must be loosened and the burner must be rotated to the right. Bend the top of the back wall up slightly and tilt the burner to remove it.

→ Disconnect the fuel line and move it to the side.



1 Fuel line

→ Remove the screws from the burner cover.



1 Burner cover

2 Screws

→ Disconnect the cable from the ignition transformer.



1 Cable, ignition transformer

→ Pull the top of the back wall up, tilt the burner.



1 Ignition transformer

→ Tilt the burner out and remove it.



The burner is assembled in reverse order.

5.7 Burner

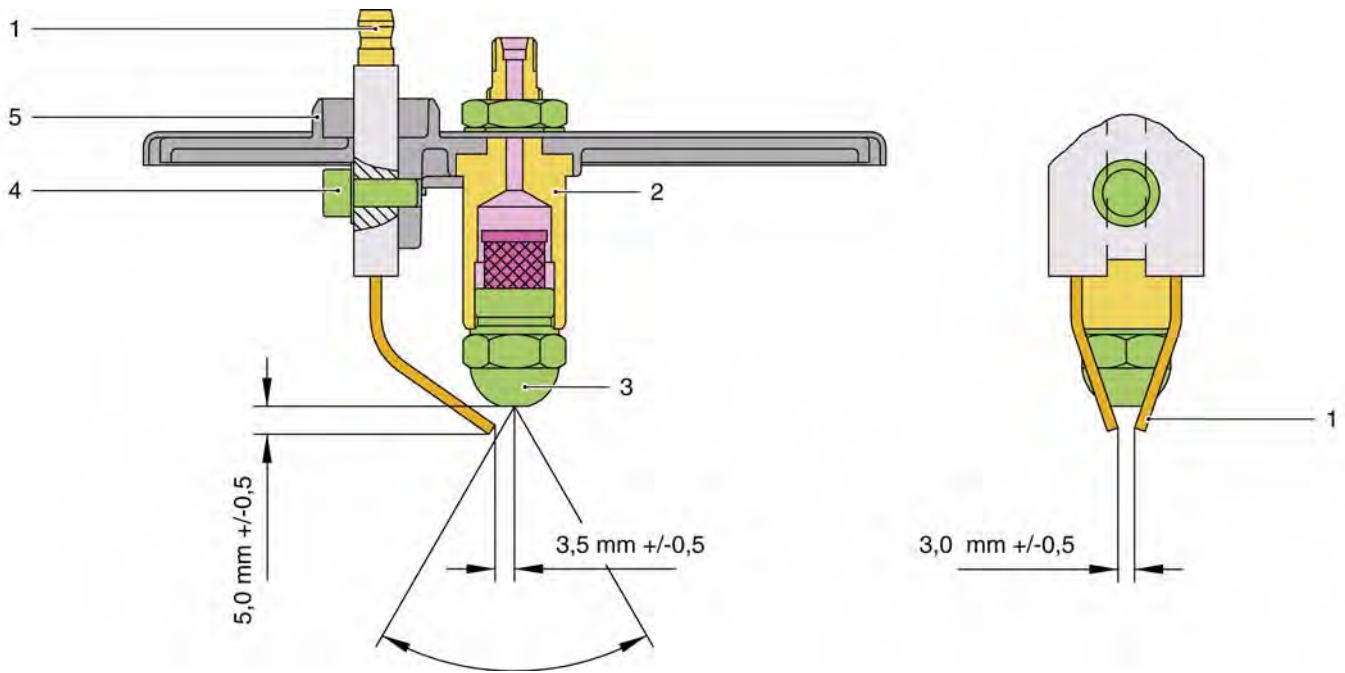

- 1 Ignition electrodes
- 2 Fuel nozzle holder
- 3 Fuel nozzle, spray angle 45° or 60°, depending on the type of appliance
- 4 Screw
- 5 Burner cover

Note

This appliance does not have a sight glass in the burner cover.
In order to ensure a safe ignition of the injected fuel, the adjustment dimensions must be strictly adhered to.

Ignition electrodes

There is a strong spark created between the two ignition electrodes to ensure that the injected fuel will ignite.

The necessary ignition voltage is generated by the ignition transformer.

The exact adherence to the adjustment dimensions is a basic requirement for the proper function of the burner, for good exhaust values and the long idle time of the ignition electrodes.

There is always a ignition spark between the two ignition electrodes, during cold and hot water operation (continuous ignition). This is a safety measure, so that injected fuel will be ignited in any case and cannot accumulate unburned in the on-demand heater (deflagration hazard).

5.7.1 Disassemble the burner

→ Pull off the flame ring, if it does not remain in the boiler during removal.



- 1 Ignition transformer
- 2 Burner cover
- 3 Flame ring
- 4 Pressure plate

→ Pull off the pressure plate.



- 1 Pressure plate

→ To replace the ignition electrodes, remove the screw and take out the ignition electrodes.

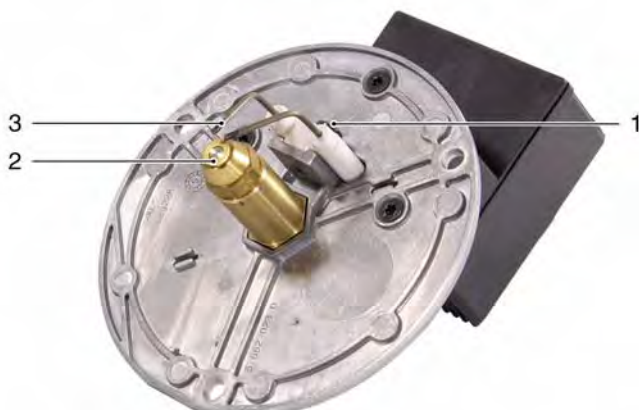

- 1 Screw of the ignition electrodes
- 2 Fuel nozzle
- 3 Ignition electrodes

→ To replace the burner nozzle, remove the nut and take out holder with the fuel nozzle.



- 1 Ignition electrodes
- 2 Screw of the ignition electrodes
- 3 Nut
- 4 Fuel nozzle holder
- 5 Fuel nozzle

→ To replace the ignition transformer, remove the screw and take out the ignition transformer.



- 1 Ignition transformer screws

5.8 Hand spray gun and triple nozzle

5.8.1 Hand spraygun



- 1 Replacement gun
- 2 Spray lance
- 3 Series gun

Note

There are no spare parts available for the series gun.
There are Disis spare parts available for the series gun.

5.8.2 Triple nozzle

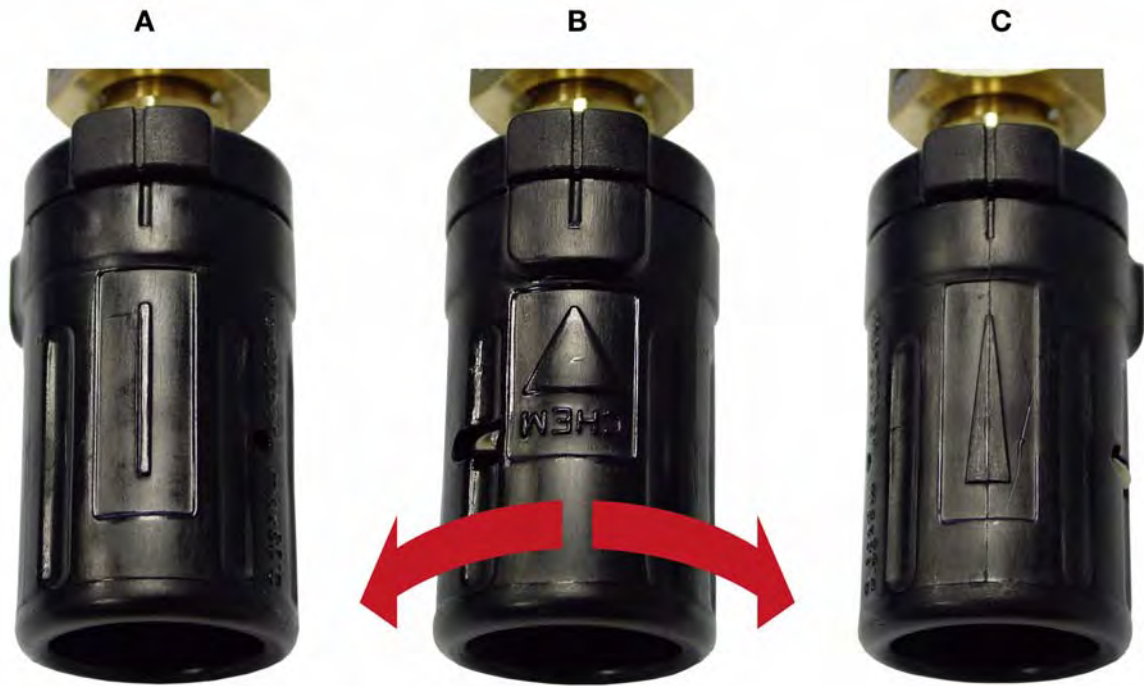

The triple nozzle can be adjusted to three different settings.

By rotating the nozzle head, you can switch between the chemical nozzle and the high pressure nozzles. The symbols on the nozzle head show which nozzle type is selected.

Setting A means high pressure point jet.

Setting B means low pressure flat jet.

This setting is used to apply the detergent.

Setting C means high pressure flat jet.

To adjust the needed type of nozzle, the gun must be closed and the nozzle head must be rotated to the settings shown above (A, B, C).

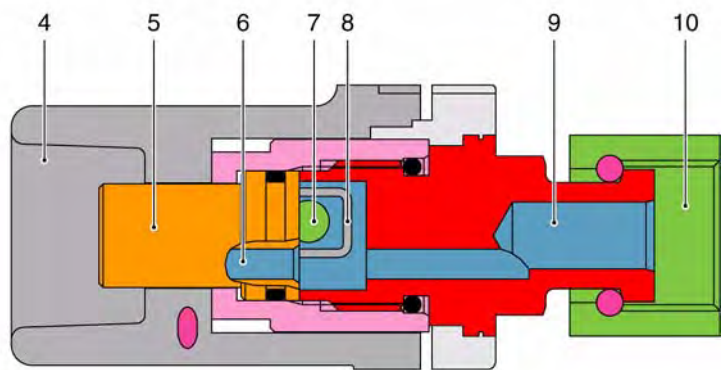

1 High pressure point jet (A)

2 High pressure flat jet (C)

3 Low pressure flat jet (B)

4 Adjustable nozzle head

5 Nozzle

6 Nozzle channel

7 Valve ball 2x

8 Valve ball cage

9 High pressure channel

10 Spray pipe connection

5.9 Remove the top part with the on-demand heater

The entire top part must be removed to gain access to the high pressure pump.

A workshop lifting platform is recommended for this procedure.

Also see chapter 6.1 Brief overview, dismantling / assembly.

5.9.1 Remove high pressure hose (UX version only)

- Completely unwind the high pressure hose.
- Pull out the safety clip.

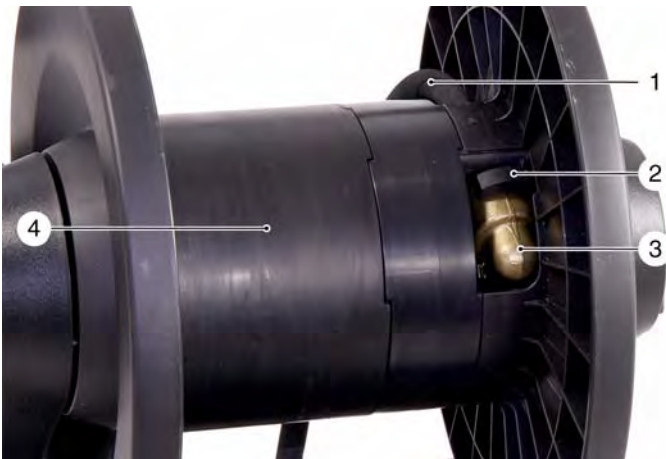

- 1 high pressure hose
- 2 Safety clip
- 3 High pressure outlet, hose drum
- 4 Hose drum

- Pull the high pressure hose out of the high pressure outlet.



- 1 high pressure hose
- 2 Washers (3x)

- Thread the high pressure hose out of the appliance.

5.9.2 Close the fuel lines

In order to prevent fuel from leaking while removing the fuel tank, the supply and return lines must be connected.

- Tilt the appliance back and rest it.
- Pull out the spring clip on the fuel return hose on the fuel pump.
- Pull out the spring clip on the fuel supply hose behind the fuel filter.

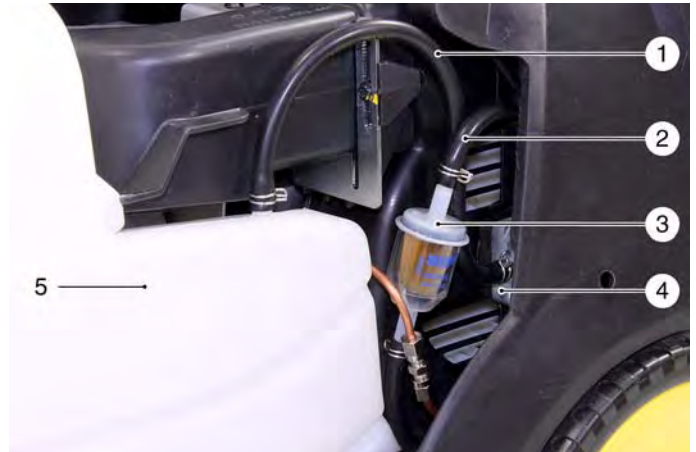

- 1 Fuel hose, return
- 2 Fuel hose, supply
- 3 Fuel filter
- 4 Fuel pump
- 5 Fuel tank

- Pull out the fuel supply hose behind the fuel filter.
- Pull the fuel return hose out of the fuel pump and attach it to the fuel filter.

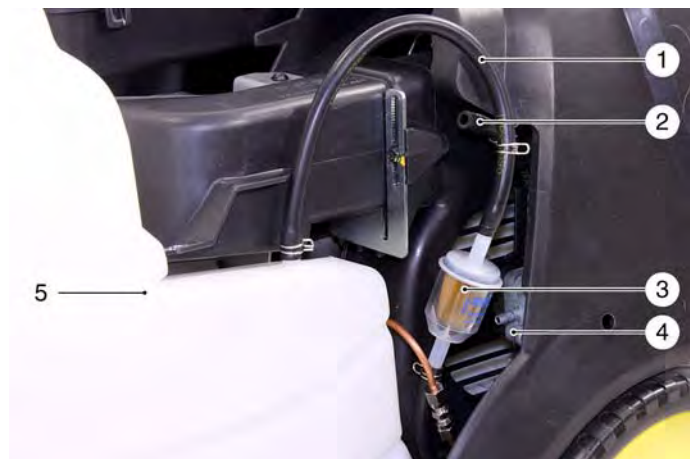

- 1 Fuel hose, return
- 2 Fuel hose, supply
- 3 Fuel filter
- 4 Fuel pump
- 5 Fuel tank

- Disconnect the fuel line at the tank.



- 1 Fuel line to burner
- 2 Fuel line from the fuel pump

5.9.3 Disconnect the connections on the burner

- Set up the appliance.
- Unlock the holding clip of the temperature sensor with a tool, without damaging the temperature sensor and remove it from the exhaust stack.
- Remove the temperature sensor and carefully unthread the capillaries from the back wall.

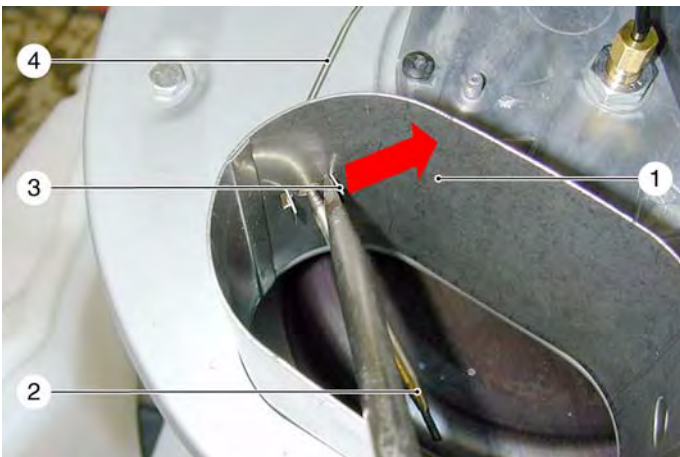

- 1 Exhaust nozzle, on-demand heater
- 2 Temperature sensor
- 3 Retaining clip
- 4 Capillary exhaust temperature monitor

- Unlock the protective conductor on the burner cover and remove it from the back wall.
- Disconnect the cable from the ignition transformer.

5.9.4 Disconnect the connections on the pump head

- Pull the detergent hose off of the pump head.



- 1 Detergent hose
- 2 Pump head

- Slightly raise the pump kit.
- Unscrew locking screws.
- Remove the safety block.

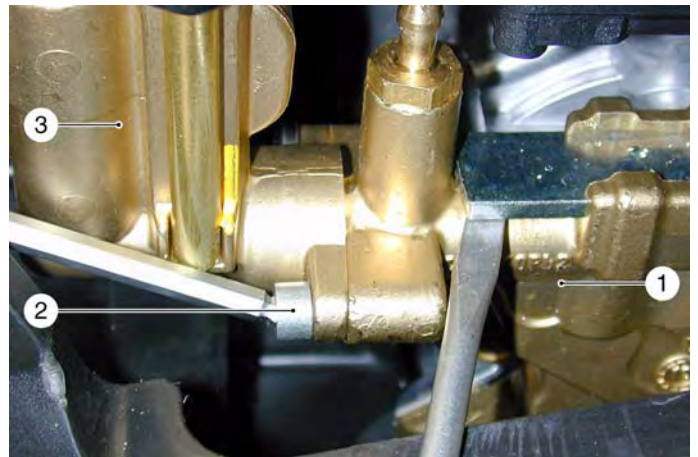

- 1 Pump set
- 2 Fastening screw (2x)
- 3 Safety block

5.9.5 Loosen the base plate of the on-demand heater

→ Remove two screws on the base plate of the on-demand heater.

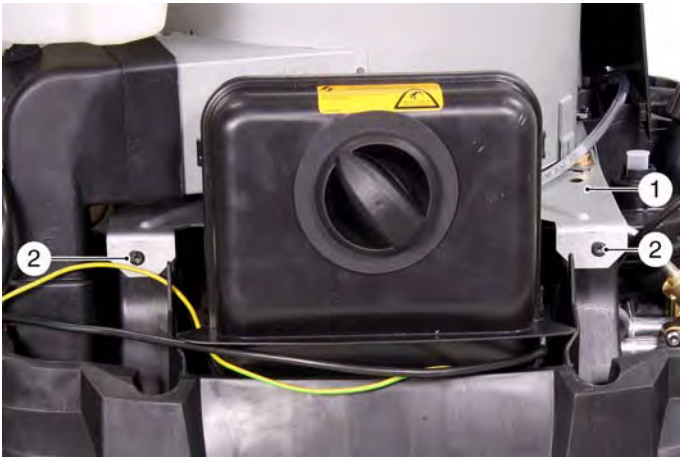

1 Base plate for on-demand heaters
2 Screw

→ Loosen the screw on the right of the on-demand heater and swivel the holding plate to the side.



1 Screw
2 Holding plate

→ Lift the electric box out of its holder by alternately lifting it toward the top.



1 Electronics system
2 Top part of electric box

→ Rest the electric box toward the front.

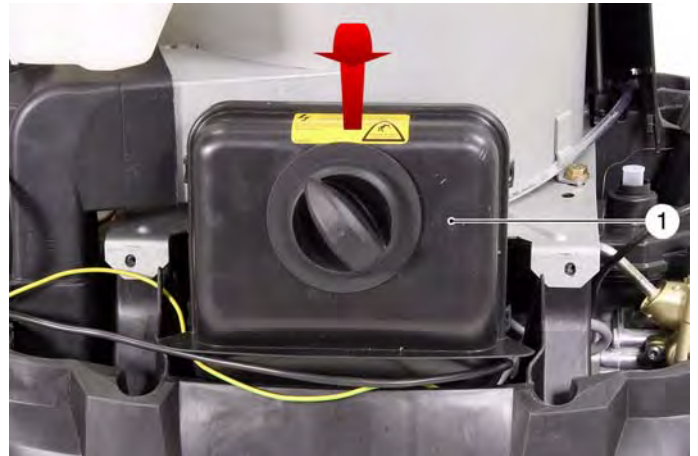

1 Electronics system

→ Disconnect the connector of the temperature control 95°C.

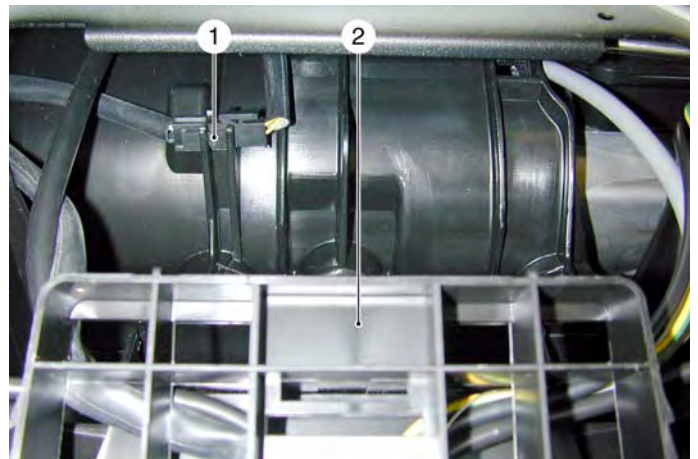

1 Socket plug connection
2 Electronics system

5.9.6 Pull the on-demand heater assembly out toward the top.

- Place it behind the appliance.
- Unwind the mains cable and place it on the floor.
- Put one foot on the foot rest of the appliance.
- Carefully lift the on-demand heater assembly by the bow out of the floor group toward the top.



→ Lay the appliance down.



→ Pull out the safety clip of the high pressure line.



1 High pressure line

→ Remove the bottom of the appliance from the on-demand heater.

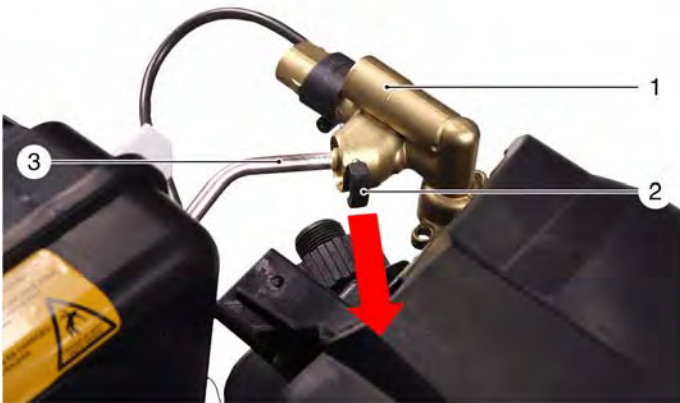

1 Safety block
2 Safety clip
3 High pressure line

→ Remove the safety block.



1 Safety block
2 High pressure line

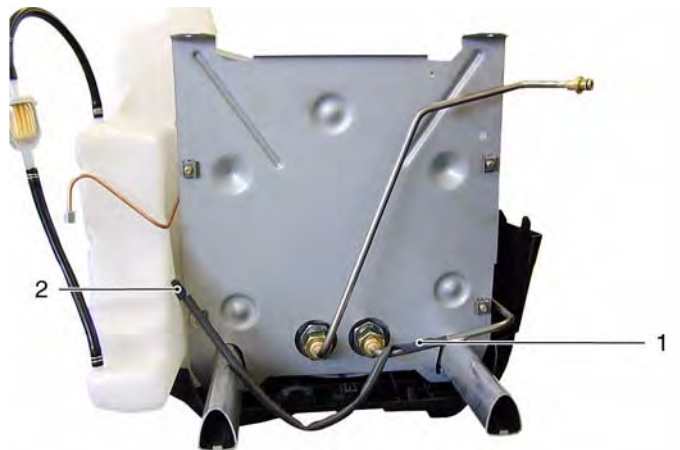

1 Temperature controller 95°C
2 Connector temperature controller 95°C

Note

When assembling the appliance make sure that the mains cable is routed through the holder on the motor cover and that the traction relief is seated correctly on the floor group.

5.10 Floor group

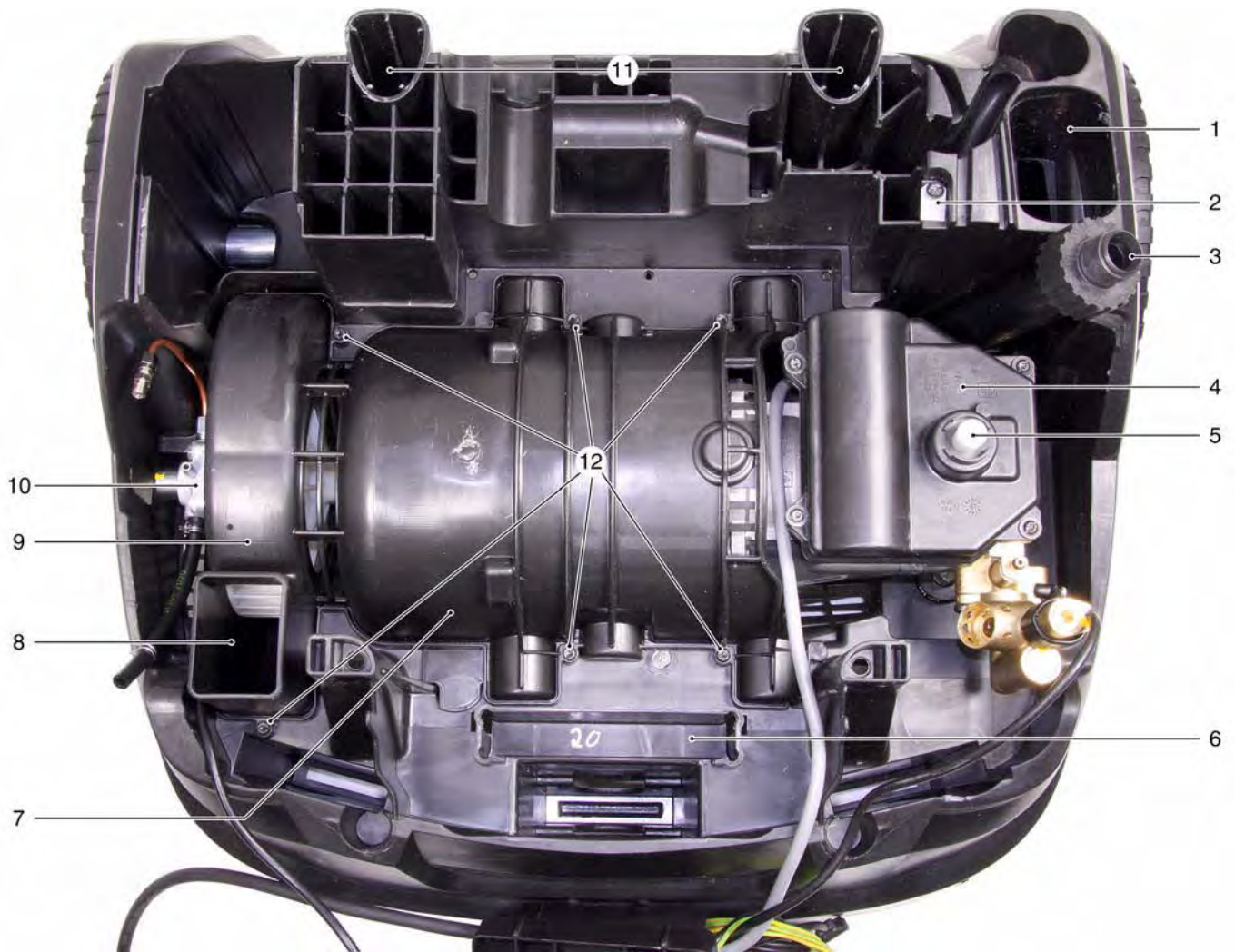

- 1 Storage for spray pipe
- 2 Holding plate for the base plate of the on-demand heater
- 3 Water inlet with water fine filter
- 4 Electric box, motor
- 5 Blind plug (do not remove, do not fill in liquids)
- 6 Holder, electric box
- 7 Cool air guidance and motor cover
- 8 Burner blower outlet
- 9 Burner fan
- 10 Fuel pump
- 11 Intakes, aluminium pipes
- 12 Screws, motor cover

Note

The blind plug closes a production-related opening not suited for filling in liquids.

5.10.1 Remove the motor/pump unit

- Remove 6 screws from the motor cover.
- Remove the motor cover.

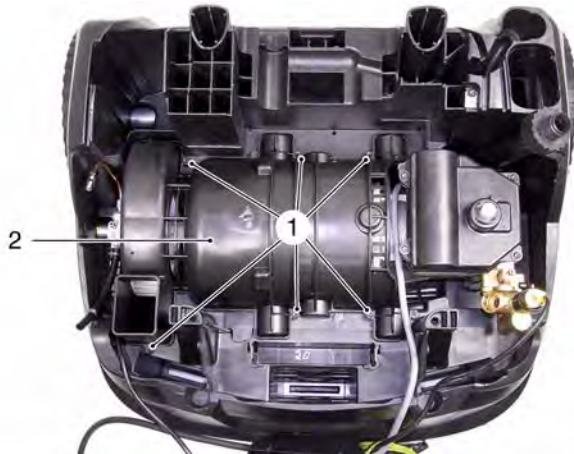

- 1 Screws, motor cover
- 2 Cool air guidance and motor cover



- 1 Motor/pump unit
- 2 Side motor intake (2x)
- 3 Centre motor intake (2x)
- 4 Fuel pump

- Lift the motor/pump unit from the floor group.
- Remove the fuel pump.

5.11 Motor/pump unit

5.11.1 View from above



- 1 Water inlet with water fine filter
- 2 Electric box, motor
- 3 Screws, electric box (4x)
- 4 Pump head
- 5 Safety block
- 6 Motor
- 7 Ventilator wheel, motor cooling
- 8 Ventilator wheel, burner blower

5.11.2 Left view

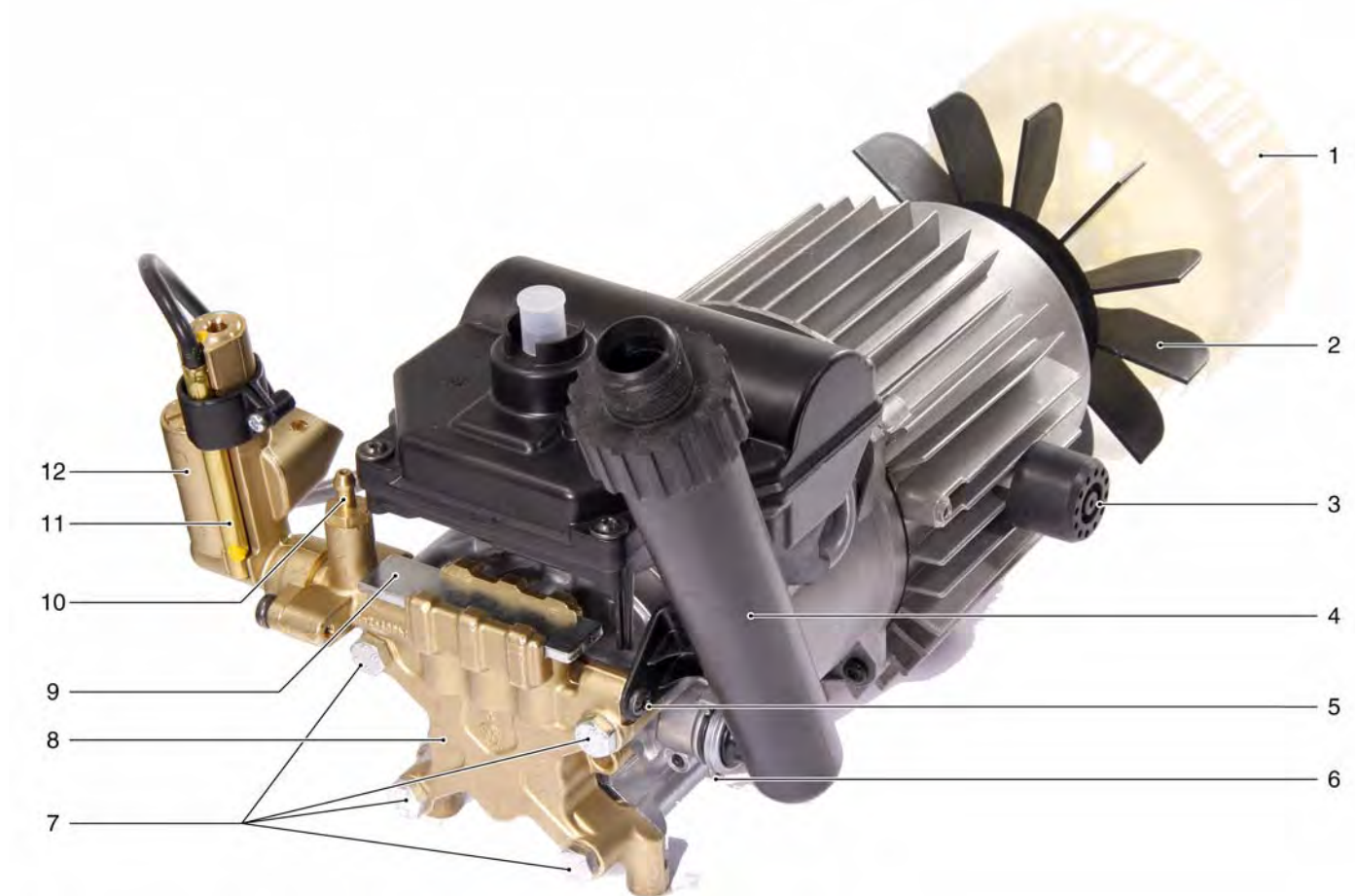

- 1 Ventilator wheel, burner blower
- 2 Ventilator wheel, motor cooling
- 3 Motor intake
- 4 Water inlet with water fine filter
- 5 Fastening screw, water inlet
- 6 Holding clip, water inlet
- 7 Pump head screws
- 8 Pump head
- 9 Holding plate, pressure valves
- 10 Connection detergent suction
- 11 Reed switch, lack of water fuse
- 12 Safety valve

5.11.3 Sectional illustration

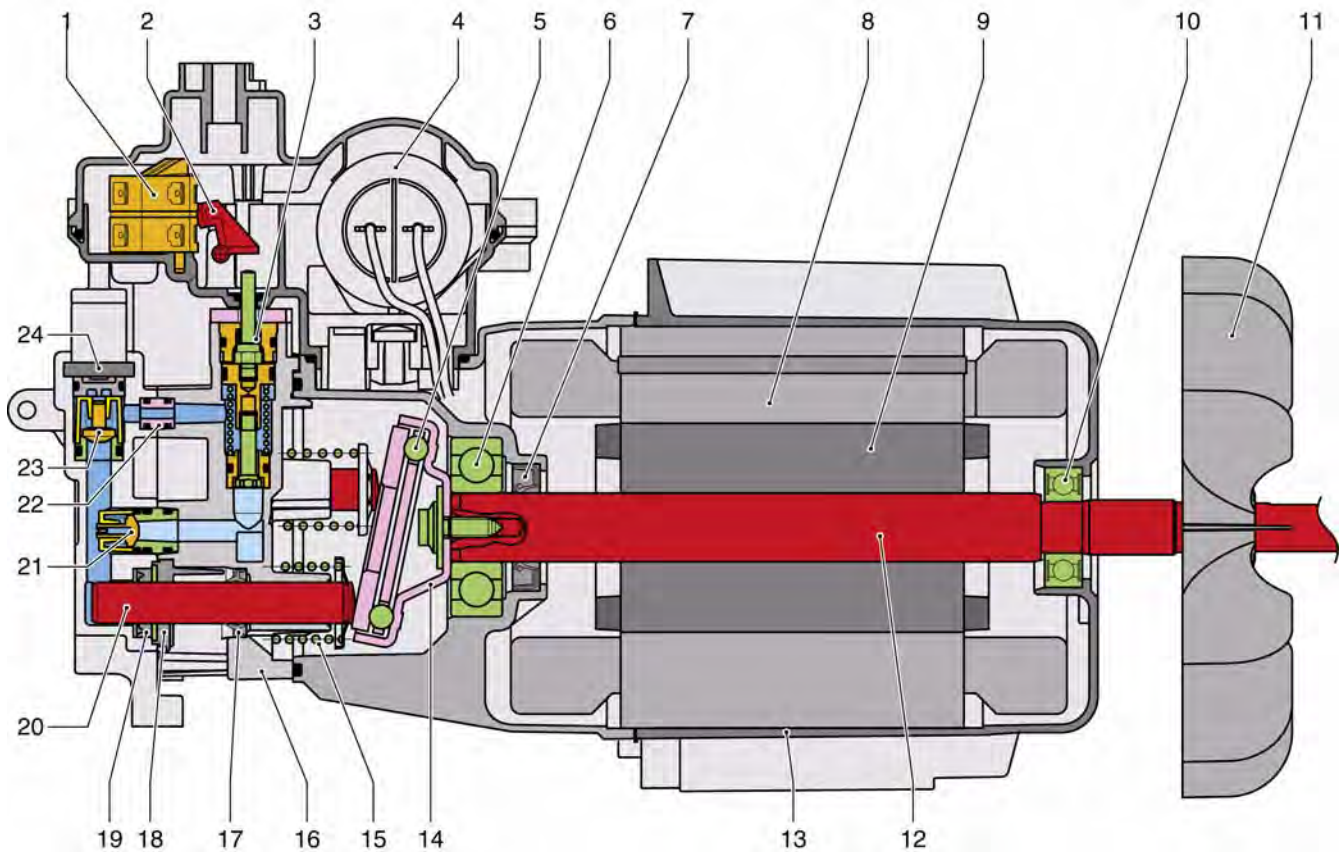

- 1 Pressure switch
- 2 Switch cam
- 3 Overflow valve (control piston, pressure switch)
- 4 Capacitor
- 5 Axial ball bearing, swash plate
- 6 Motor bearing, front (A bearing)
- 7 Shaft seal ring, motor shaft
- 8 Motor winding (stator)
- 9 Solenoid (rotor)
- 10 Motor bearing, rear (B bearing)
- 11 Ventilator wheel, motor cooling
- 12 Motor shaft
- 13 Motor casing
- 14 Swash plate
- 15 Piston spring
- 16 Piston casing
- 17 Oil seal
- 18 Support disc
- 19 High pressure seal
- 20 Piston
- 21 Suction valve
- 22 Connecting sleeve
- 23 Pressure valve
- 24 Holding plate



1 Overflow valve (control piston, pressure switch)

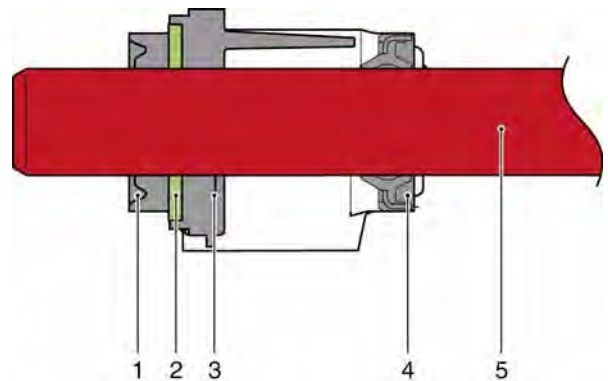

- 1 High pressure seal
- 2 Disc
- 3 Support disc
- 4 Oil seal
- 5 Piston

5.11.4 Cross section of pump head front view

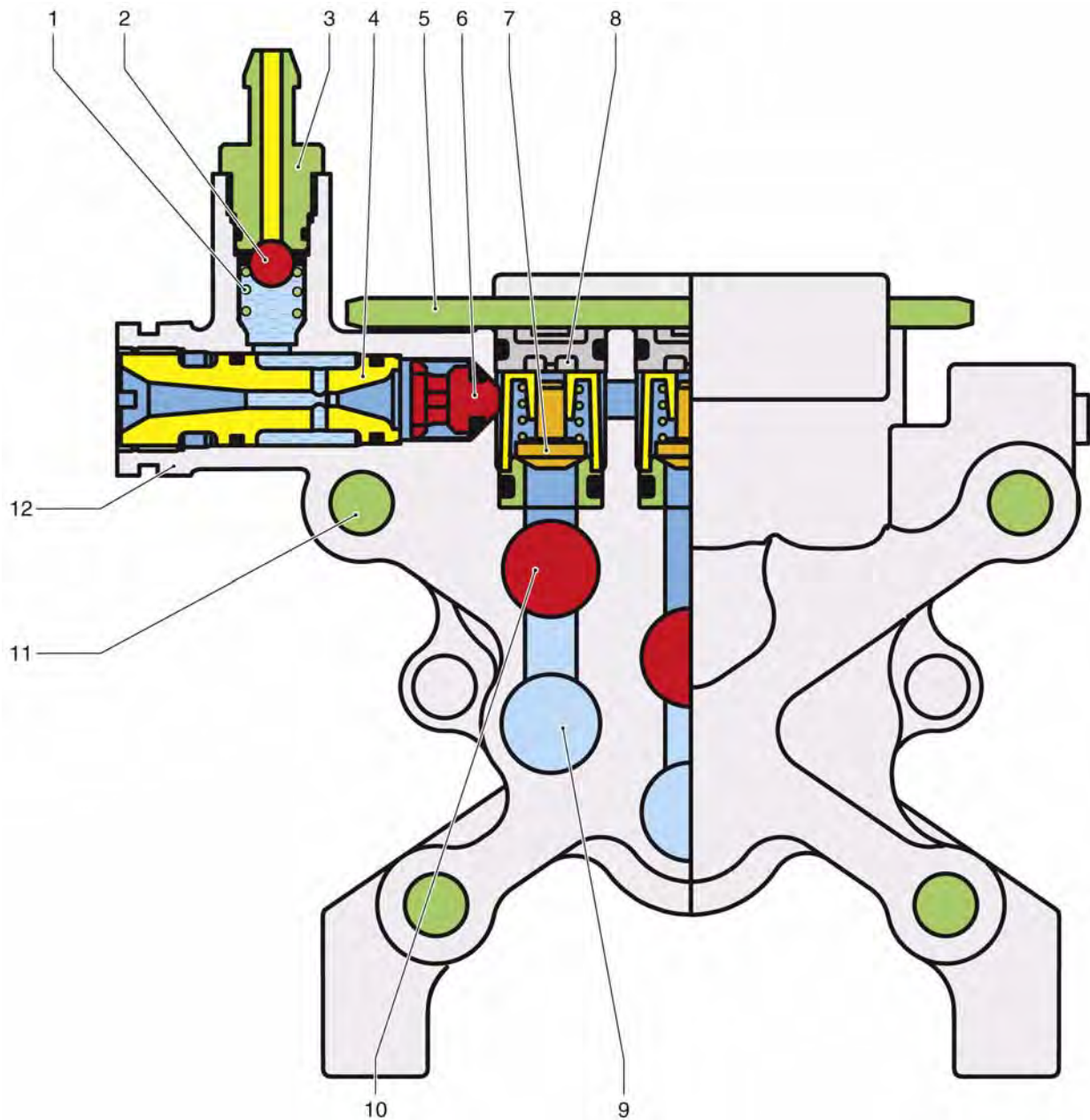

- 1 Pressure spring
- 2 Sphere
- 3 Connection of detergent hose
- 4 Injector
- 5 Holding plate
- 6 Pressure holding valve
- 7 Pressure valve
- 8 Stopper
- 9 Suction area
- 10 Piston
- 11 Cylinder head screws
- 12 Connection, safety block

5.11.5 Single parts, pump head

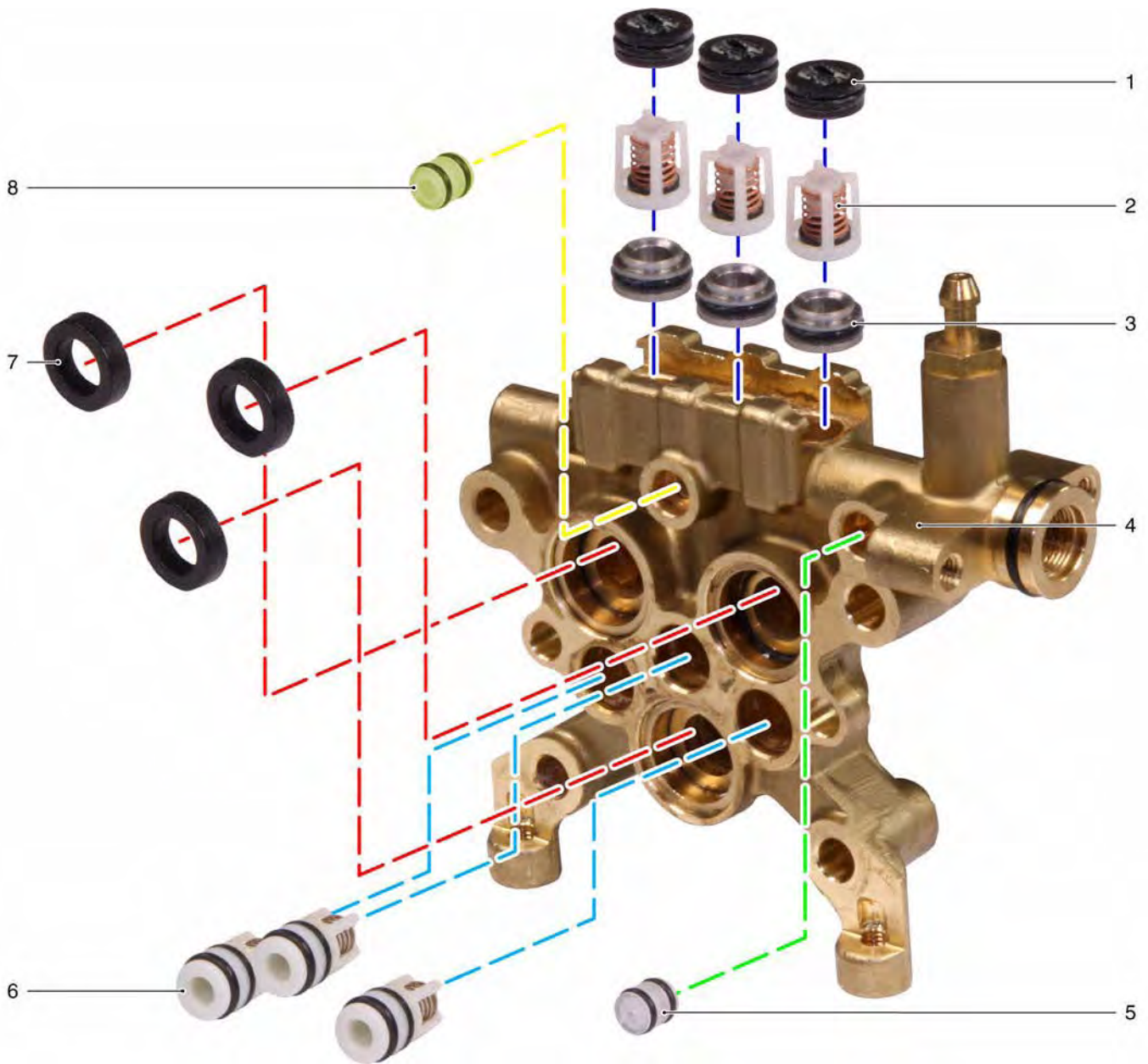

- 1 Cap
- 2 Pressure valve
- 3 Valve seat
- 4 Pump head
- 5 Restrictor
- 6 Suction valve
- 7 High pressure seal
- 8 Connecting sleeve

5.11.6 Electric box, motor (open)

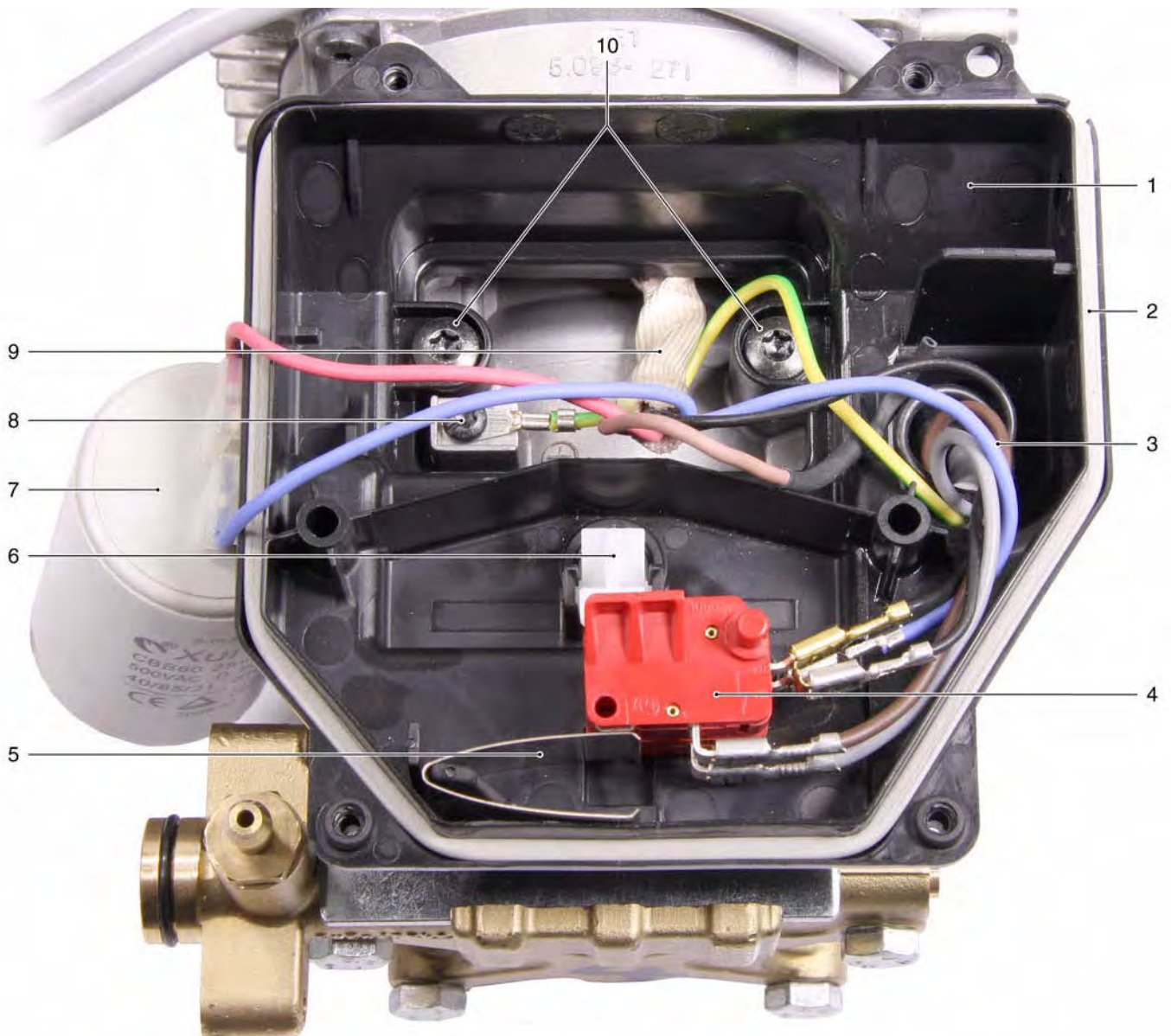

- 1 Electric box, motor
- 2 Seal
- 3 Cable to the electric box, appliance
- 4 Pressure switch
- 5 Leaf spring
- 6 Switch cam
- 7 Capacitor
- 8 Connection, protective conductor
- 9 Connecting cable, motor
- 10 Fastening screws, electric box

Note

To remove the pump head, the electric box must be taken out - otherwise, the control piston of the pressure switch may be damaged.

→ Remove the fastening screws and lift the electric box from the motor.

5.11.7 Remove the ventilator wheel of the burner blower

→ Remove the screw and pull the ventilator wheel off.

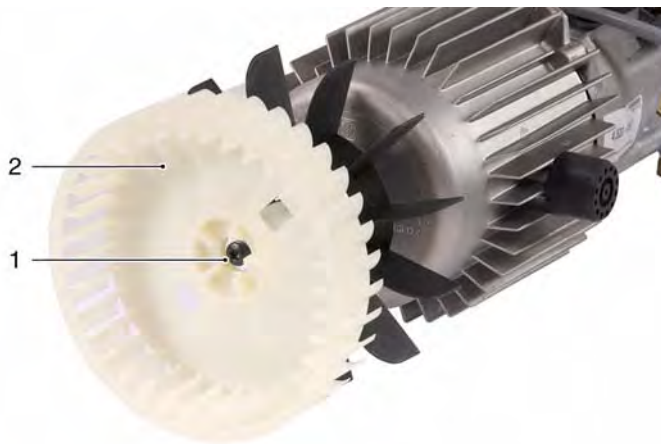

- 1 Screw
- 2 Ventilator wheel, burner blower

5.11.8 Remove the safety block

→ Remove the screws and take off the safety block.

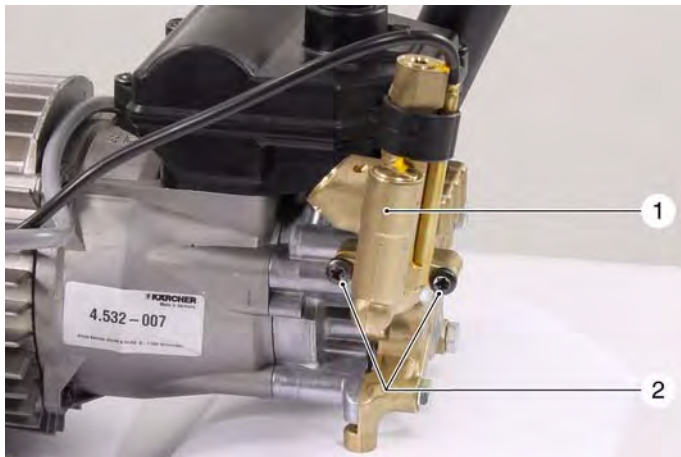

- 1 Safety block
- 2 Screws

5.11.9 Safety block, front view

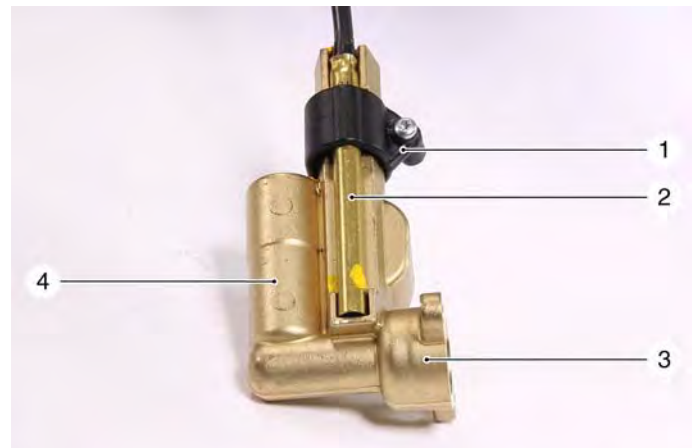

- 1 Fastener, reed switch
- 2 Reed switch
- 3 Connection to the pump head
- 4 Safety valve

Note

When installing the reed switch, make sure that the mark on the reed switch is flush with the top edge of the safety block.

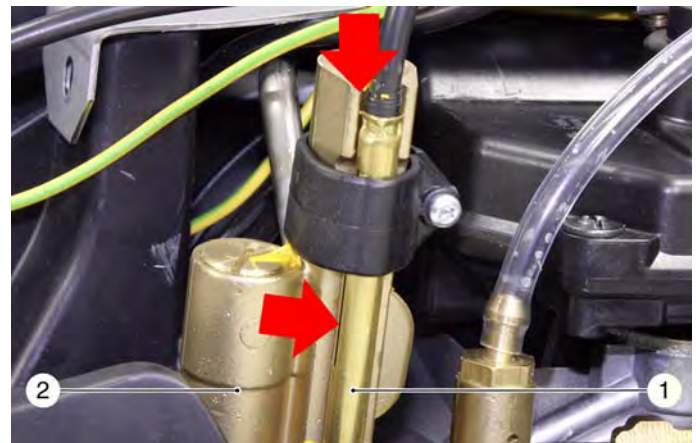

- 1 Reed switch
- 2 Safety valve

5.11.10 Safety block, rear view

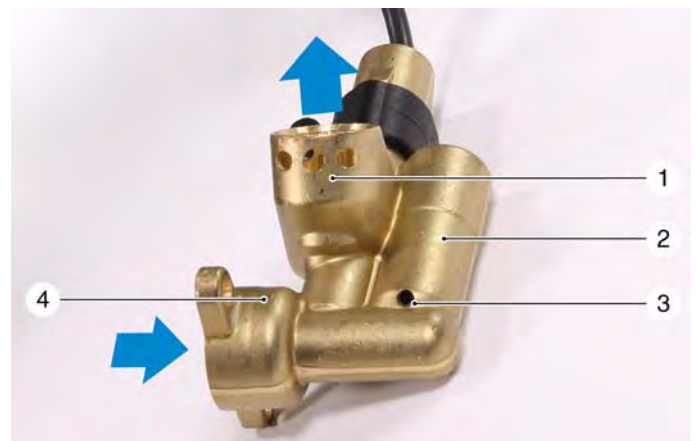

- 1 Connection of high pressure line to the on-demand heater
- 2 Safety valve
- 3 Output, safety valve
- 4 Connection to the pump head

5.11.11 Safety block, cross section drawing

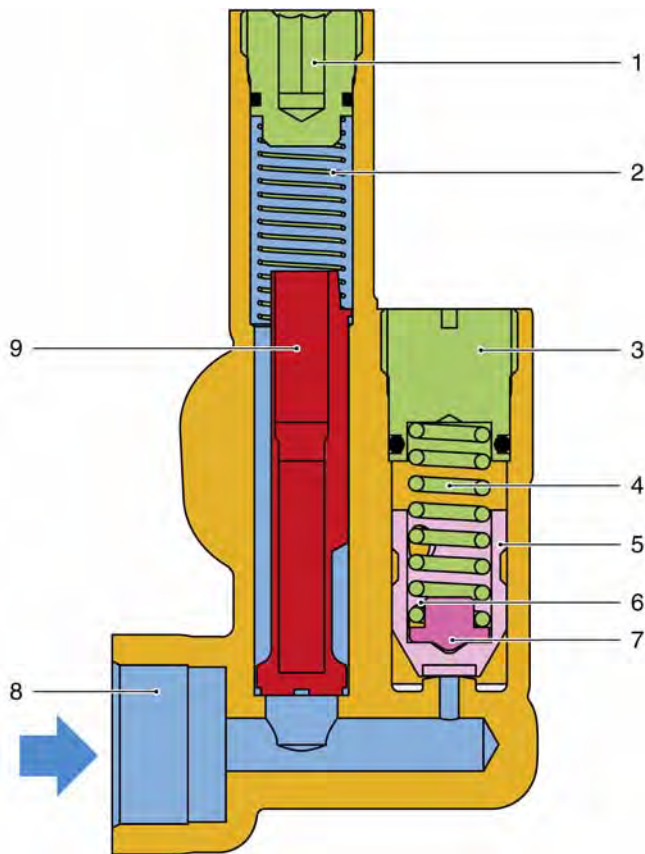

- 1 Locking screw, lack of water fuse
- 2 Spring
- 3 Adjustment screw, safety valve
- 4 Spring, safety valve
- 5 Valve disks
- 6 Outlet bore, high pressure (not visible here)
- 7 Spring plate
- 8 High pressure inlet from pump head
- 9 Solenoid piston, lack of water fuse

5.11.12 Remove the detergent injector and the pressure holding valve

The detergent injector is screwed into the pump head with a thread.

- ➔ Unscrew the detergent injector.
- ➔ Remove the pressure holding valve.

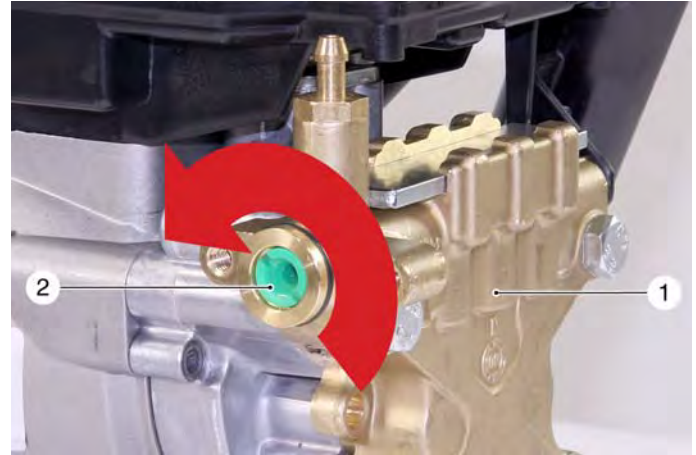

- 1 Pump head
- 2 Detergent injector

5.11.13 Remove the water inlet

- Remove the fastening screw of the water inlet on the pump head.
- Pull the holding clip downwards.
- Remove the water inlet toward the side.

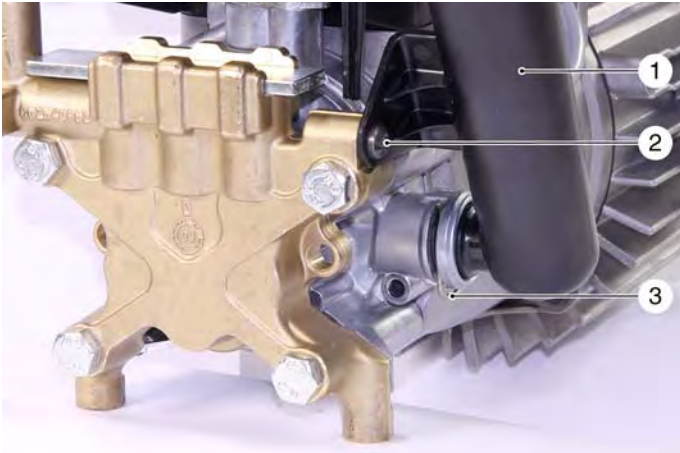

- 1 Water inlet
- 2 Screw
- 3 Retaining clip

5.11.14 Remove the control piston for the pressure switch.

Note

The removal of the pressure switch control piston is not required to remove the pump head and the piston casing, only in case of a repair.

- Remove the electric box of the motor (see Chapter 5.11.6 Electric box, motor (open)).
- Remove the fastening screws of the holding plate.
- Remove the holding plate.



- 1 Control piston, pressure switch
- 2 Holding plate, control piston
- 3 Screws

- Remove the control piston.



- 1 Control piston, pressure switch

5.11.15 Disassemble the pump

Remove the pump head

The pump head screws go through the piston casing and are screwed into the motor casing.

Therefore, in order to be able to remove the pump head without having to remove the piston casing, the piston housing must be fastened to the motor casing with two installation screws.

There is no thread installed in these bores in the motor casing by the manufacturer. You have to use thread cutting screws.

- Coat two cutting screws (M5x30) lightly with oil and turn them through the piston casing into the motor casing.
- Remove the pump head screws.

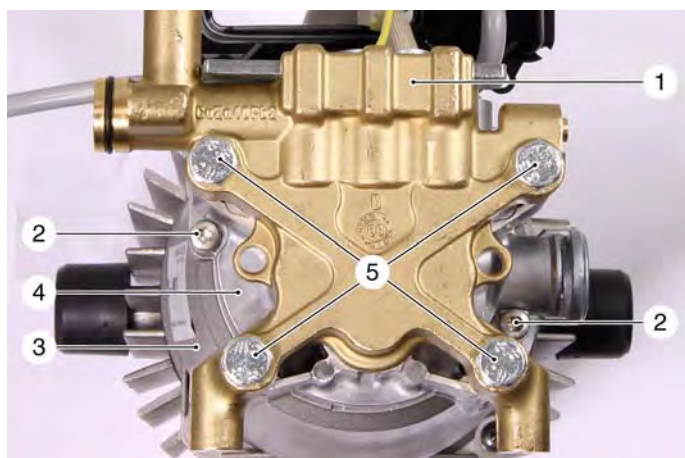

- 1 Pump head
- 2 Cutting screws
- 3 Motor casing
- 4 Piston casing
- 5 Pump head screws

- Pull off the pump head.



- 1 Pump head

- Place the pump kit vertically.
- Unscrew the cutting screws alternatingly step by step.
- Remove the piston casing.

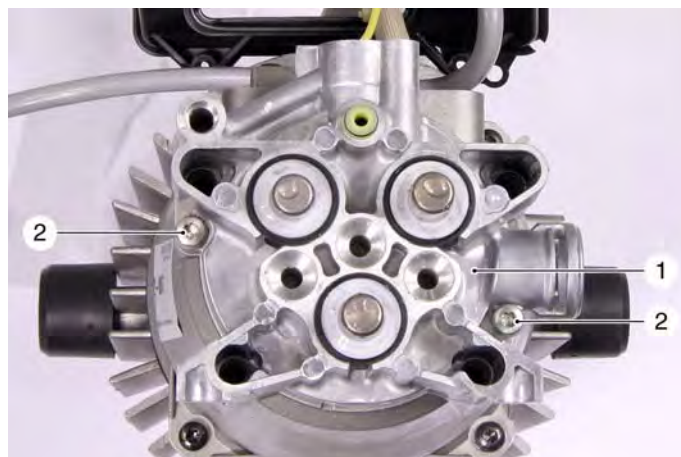

- 1 Piston casing
- 2 Cutting screws

- Replace the oil and seal ring.
- Check the axial ball bearing of the swash plate.



- 1 Motor casing
- 2 Oil fill
- 3 Swash plate with axial ball bearing
- 4 Fastening screw, swash plate
- 5 Washer ring

5.11.16 Test run

After repairing the pump, you must perform a test run to check the pump for leaks and proper operation. This can be done without connecting the on-demand heater.

- Assemble the motor/pump unit and place it into the chassis **without the fuel pump**.
- Install the cool air guidance and the motor cover.



- 1 Chassis floor group
- 2 Cool air guidance and motor cover

Appliance with hose drum

- Connect the high pressure hose with the hand spray gun to the safety block high pressure outlet.
- Connect the water supply to the water inlet.
- Connect the mains cable.
- Turn on the machine.

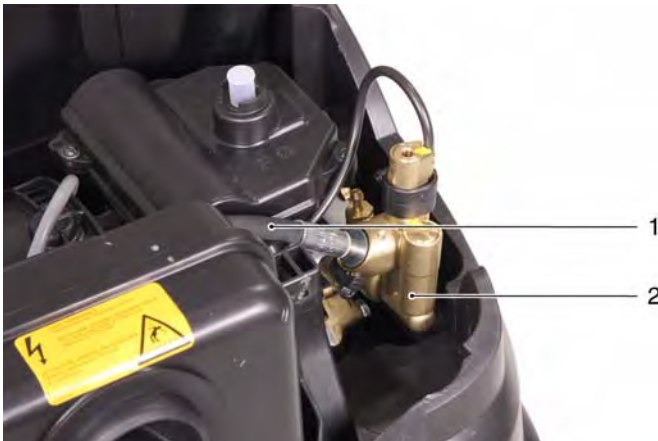

- 1 high pressure hose
- 2 Safety block

Appliances without hose drum

- Connect the swivel (see special tools) to the safety block of the high pressure outlet and connect the high pressure hose with hand spray gun to it.
- Connect the water supply to the water inlet.
- Connect the mains cable.
- Turn on the machine.

6 Basic settings and service procedures

6.1 Brief overview, dismantling / assembly

6.1.1 Upper section

The entire top part must be removed to perform the following work:

- Working on the pump
- Working on the motor
- Working on the electric box of the motor
- Working on the blower
- Working on the fuel pump

The exact explanation of the work steps is detailed in Chapters 5.9 to 5.11.

Work steps for dismantling:

- Completely remove the high pressure hose and put it to the side.
- Lay the appliance on its rear.
- Reconnect the fuel hoses on the fuel tank and the fuel pump.
- Open the screw connection on the fuel line.
- Set up the appliance.
- Remove the exhaust temperature sensor (holding clip).
- Unplug the protective conductor cable on the burner cover.
- Unplug the ignition transformer.
- Pull the detergent hose off of the pump head.
- Loosen the screws on the base plate of the on-demand heater (2 screws in front, 1 screw on the right).
- Remove the safety block (2 screws).
- Remove the high pressure on the safety block (holding clip).
- Remove the electric box and rest it toward the front.
- Disconnect the connector of the temperature control 95°C.
- Place it behind the appliance and pull the top part a little out of the bottom part.
- Lay the appliance on its rear.
- Completely remove the bottom part from the top part.

The electric box on the motor is now accessible. Further to the removal of the pump kit, blower, fuel pump.

- Remove the motor cover (6 screws).
- Remove the fuel pump.
- Remove the pump kit.
- Perform repairs on pump, motor, electrical system.

Carry out a brief test run before the assembly!

Work steps for assembly:

- Place the pump kit into the bottom part with all rubber buffers.
- Install the safety block (2 screws).
- Position the motor cover with rubber buffers and fasten it tentatively (2 screws).

Perform a brief test run (without fuel pump).

- Attach the high pressure hose to the safety block (clip), with a swivel for the U version.

After successful test run:

- Remove the motor cover and the safety block (2 screws each).
- Install the fuel pump with coupling.
- Replace all rubber bearings.
- Install the motor cover (6 screws).
- Insert the bottom part onto the aluminium pipes of the horizontally placed top part.
- Position all hoses and cables properly.
- Set up the appliance and let the top part slide down into the bottom part.
- Install the safety block onto the high pressure line (2 screws).
- Secure the high pressure on the safety block (holding clip).

Make sure that the mains cables, other cables and hoses are routed properly!

- Attach the base plate of the on-demand heater (2 screws in front, 1 screw on the right).
- Lay the appliance on its rear.
- Connect the fuel hoses with the fuel pump and the fuel tank.
- Set up the appliance.
- Insert the temperature controller 95°C.
- Install the temperature sensor, protective conductor and the power supply of the ignition transformer.
- Guide the detergent hose through the back wall and connect it to the injector.
- Insert the electric box.
- UX version: Guide the high pressure hose through the appliance, place it on the hose drum and secure it (holding clip).

6.1.2 Back of appliance

The back of the appliance must be removed for the following work:

- Working on the heating coil
- Working on the heating coil connections
- Working on the high pressure lines
- Working on the mains cable
- Working on the fuel tank

The exact explanation of the work steps is detailed in Chapters 6.2 to 6.3.

Work steps for dismantling:

All parts are removed toward the top via the aluminium pipes.

- Dismantle the push handle (2 screws) and remove it.
- UX version: Loosen the high pressure on the hose drum (holding clip).
- Remove the hose drum (2 screws).
- Remove the tank lid.
- Remove the rear wall (2 screws).
- Replace the tank lid.

Furthermore, depending on the required work:

If necessary, remove the holding plate for the two aluminium pipes on the boiler (2 screws).

Work steps for assembly:

- After the work has been carried out: Rear wall, hose drum, reattach the push handle.
- UX version: Install the high pressure line into the hose drum and secure it (clip).

6.2 Remove the hose drum

- Remove high pressure hose as described in chapter 5.9.1 Remove high pressure hose (UX version only) .
- Remove the screws on the pushing handle and pull the pushing handle off toward the top.



- 1 Push handle
- 2 Screws

- Remove the safety clip of the high pressure line on the hose drum.

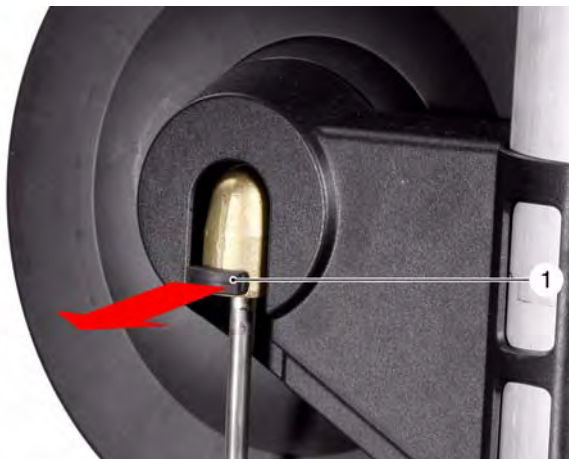

- 1 Safety clip, high pressure line.

- Remove the screws from the intakes of the hose drum.
- Pull the hose drum out of the aluminium profiles toward the top.

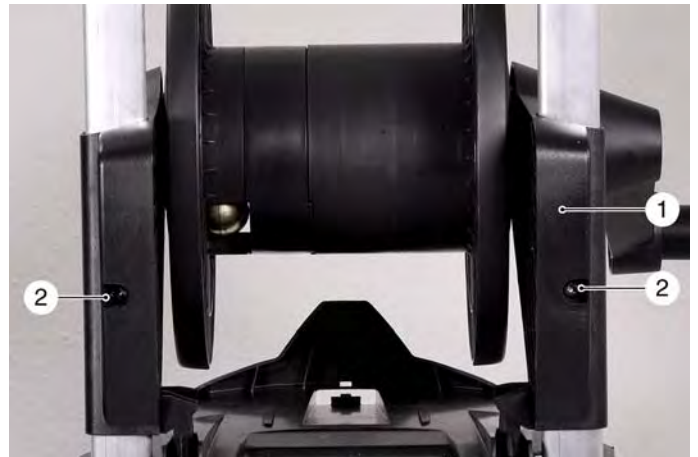

- 1 Hose drum
- 2 Screws

6.2.1 Replace the seal of the rotary grommet

→ Pull the crank straight off of the hose drum and remove the side part.

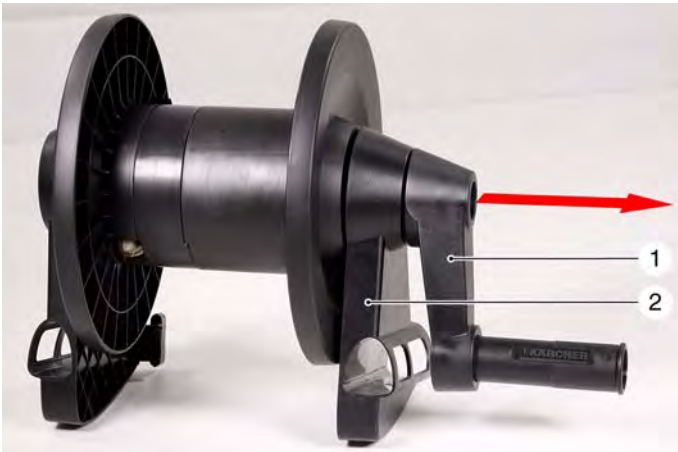

- 1 Crank
- 2 Side part

→ Remove the screws underneath the side part and take out the hose drum half shell.

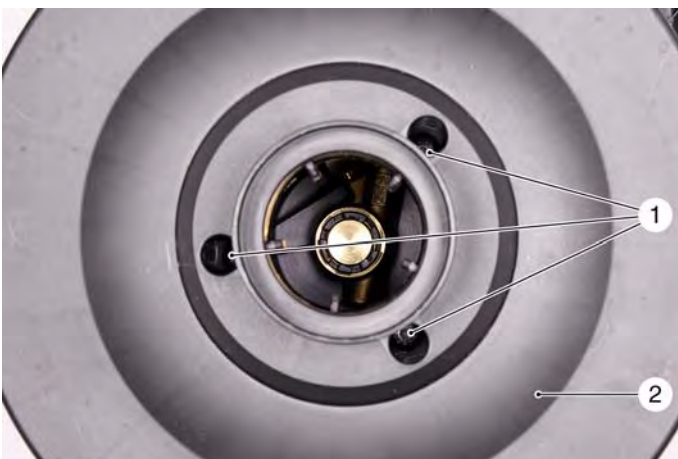

- 1 Screws
- 2 Hose drum half shell

→ Remove the seal screw.

→ Remove the knot and the axle.



- 1 Node piece
- 2 Seal screw

→ Replace seals and grease with PFAE grease (6.288-088).

→ Check the axle and the knot for wear in the area of the seals.



- 1 Seal screw
- 2 Node piece
- 3 Axle
- 4 Sealings

6.3 Remove the rear wall

- Remove the tank lid.
- Remove the rear wall (2 screws).
- Replace the tank lid.



- 1 Screws
- 2 Reservoir cover

6.4 Settings, burner

Note

An accurate basic adjustment of the burner is only possible if the heating coil was previously thoroughly desooted and the deposits were removed. Eine exakte Grundeinstellung des Brenners ist nur möglich, wenn die Heizschlange vorher gründlich entrußt und die inneren Ablagerungen entfernt wurden.

Measure water temperature

- Install the shut-off valve with thermometer (special tool) on the appliance outlet.
- Switch on the burner and bring the appliance to working pressure with full water volume via the shut-off valve.
- Measure the increase in water temperature (water outlet temperature minus water supply flow temperature).
- For target values refer to technical specifications.
- Measure the air pressure on the burner cover (special tool) and adjust it on the air slider.
- For target values refer to technical specifications.
- Measure the soot value, CO₂ content and the exhaust temperature (special tools, measuring gauges).

Adjusting the fuel pressure

- Set the fuel pressure (and water temperature) via the set screw.
- For target values refer to technical specifications.

Adjusting the soot value

- If the soot value is too high, then the air slider needs to be opened further or the fuel pressure needs to be reduced.

Adjusting the CO₂ value

- Adjust the CO₂ value by moving the air slider. Open the air slider, the CO₂ content will decrease.

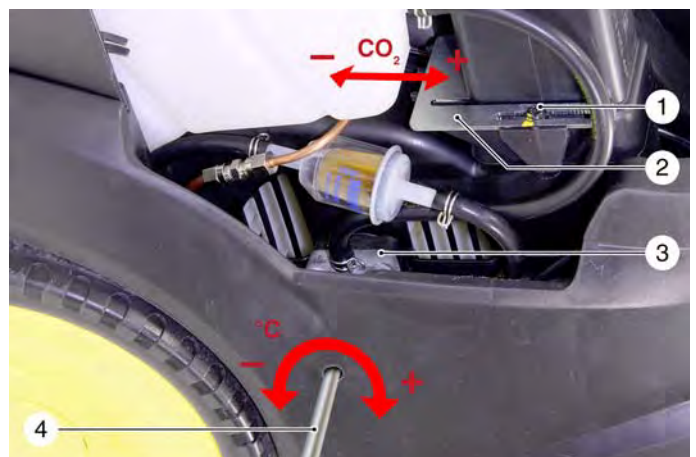

- 1 Stop screw, air volume adjustment
- 2 Slider, air volume adjustment
- 3 Fuel pump
- 4 Hexagon head screwdriver

6.5 Adjust safety valve

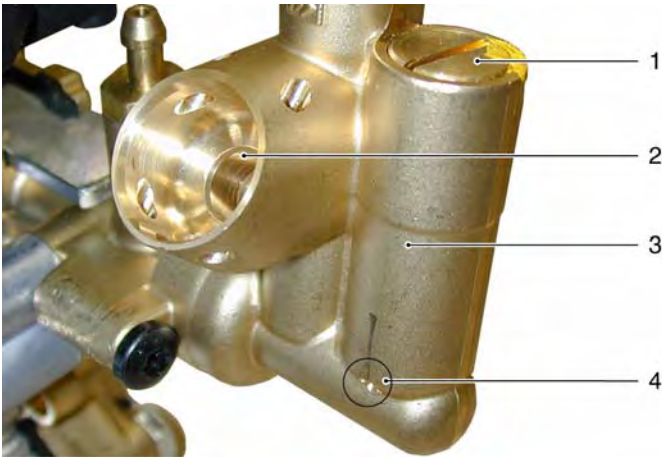

- 1 Adjusting screw
- 2 High pressure connection
- 3 Safety valve (built into the safety block)
- 4 Drain bore

Increase the opening pressure:

→ Turn the adjustment screw in a clockwise direction.

Decrease the opening pressure:

→ Turn the adjustment screw in an anticlockwise direction.

Note

The correct setting of the safety valve is only possible if the top part is removed, the leaf spring has been removed from the electric box of the motor and if the shut-off valve and the pressure gauge are connected. Opening pressure: See Specifications

Quick test:

Completely installed appliance must be turned on and off several times by opening and closing the gun. No water is to emerge from the drain bore of the safety valve.

7 Circuit diagram 0.089-212

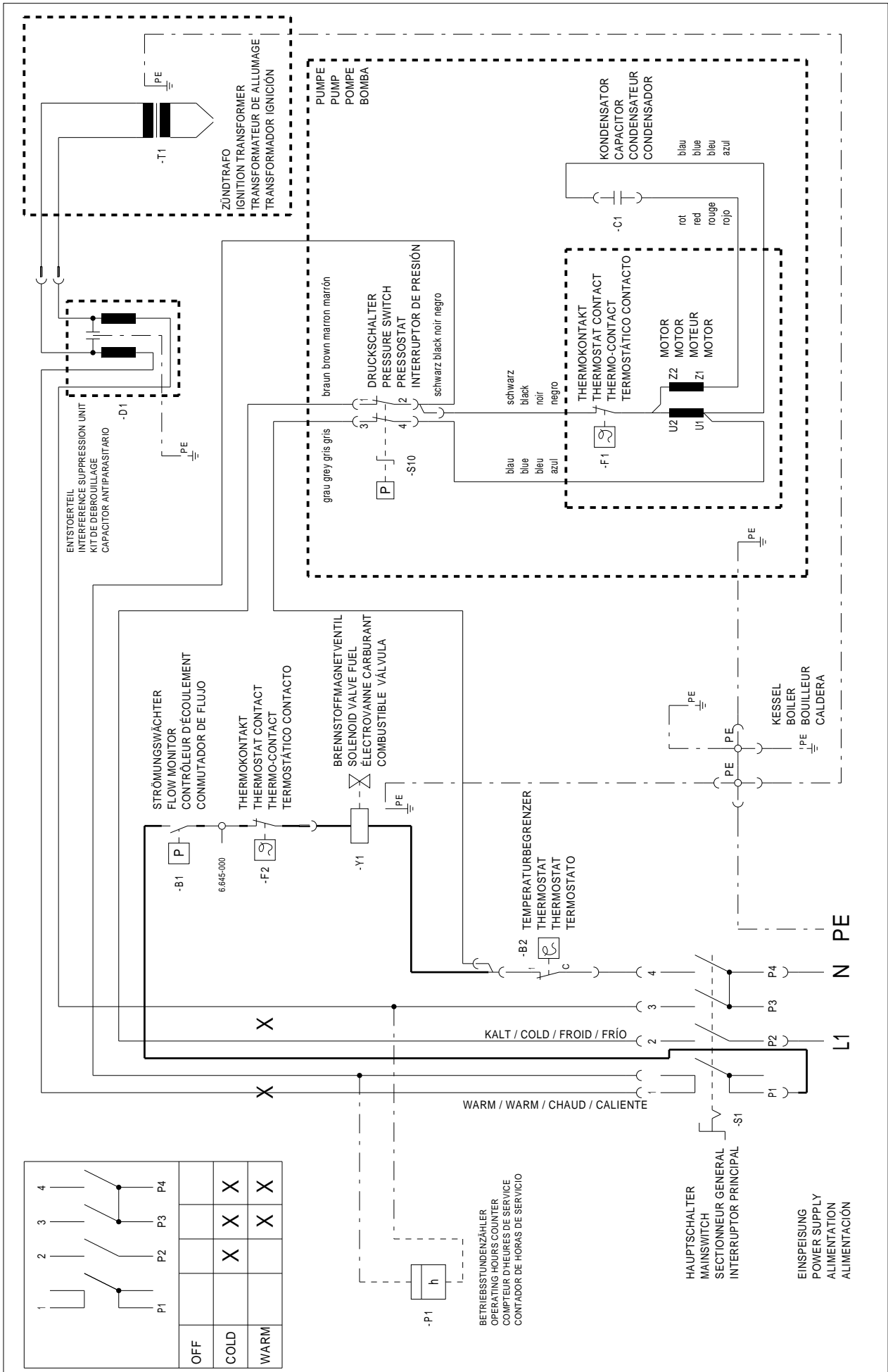

	1	2	3	4	
OFF					
COLD		X	X	X	
WARM			X	X	

8 Troubleshooting

Fault	Remedial action
Unit does not work	<ul style="list-style-type: none"> - No mains power. Check the mains connection. - Check/replace the appliance switch. - Overflow valve / pressure switch stuck - check, grease, replace. - Motor overloaded, overheated; switch off the appliance to "0/OFF" and let it cool down; switch appliance on. - The exhaust temperature limiter has been triggered, the heating coil is full of soot and exhaust temperature is too high. Press reset button of the exhaust temperature limiter. Remove the soot from the heating coil and readjust the burner if necessary.
Device is not building up pressure	<ul style="list-style-type: none"> - Air within the system, ventilate pump. With open hand spray gun turn device on and off multiple times with the device switch. Note for appliances without hose drum: By dismantling the high pressure hose from the high pressure connection the venting process is accelerated. Fill/replace external detergent container if empty. Check connections and conduits. - Filter in the water connection is dirty, clean filter. - Water supply volume too low, check water supply volume (refer to Specifications). - Tap closed, open tap. - High pressure nozzles worn, replace.
Device continuously turns on and off while hand spray gun is open	<ul style="list-style-type: none"> - High pressure nozzle plugged, clean nozzle. - Heating coil calcified, decalcify appliance.
Appliance continuously turns on and off while hand spray gun is closed	<ul style="list-style-type: none"> - Leak in the high pressure system; check the high pressure system and connections for leaks. - Pressure holding valve in the cylinder head leaks; check.
Appliance leaks, water drips from the bottom of the appliance.	<ul style="list-style-type: none"> - Pump leaks, safety valve not tight. Note: 3 drops/minute are allowed. - High pressure seals leak; replace.
Appliance is leaking oil	<ul style="list-style-type: none"> - Appliance is losing oil between the cylinder head and the piston casing; replace the oil seals.
Device is not sucking in detergent	<ul style="list-style-type: none"> - Nozzle set to "High pressure"; set the nozzle to "CHEM". - The external detergent container is empty; fill/replace external detergent container. - The filter at the detergent suction hose is dirty; clean filter. - Dosing on filter is closed; open dosing. - The backflow valve is plugged; remove the detergent hose and loosen the backflow valve using a blunt object. - Injector dirty or worn; replace injector.
Burner does not start	<ul style="list-style-type: none"> - Fuel tank empty; fill fuel. - Fuel filter dirty; change fuel filter. - Fuel valve is not opening; check, replace. - Fuel pump does not feed any fuel; check, replace the fuel pump and the drive parts. - Lack of water; check water connection/supply lines. - Ignition electrodes are dirty or worn; clean or replace the ignition electrodes. - Ignition electrodes are set incorrectly; check, correct the ignition geometry of the ignition electrodes and the fuel nozzle. - Ignition transformer defective; check.

9 Technical specifications

Technical specifications	Preliminary values	
Appliance number	1.064-001 / 1.064-002	
Description	HDS 5/11 U/UX	
Mains voltage / phase number	V / Ph	230 / 1
Supply voltage, permissible voltage tolerance	%	6
Frequency	Hz	50
Current pickup, full load (after 10 min.)	a	9,5
Connection output	kW	2,2
Electric motor speed	1/min	2790
High-pressure nozzle (UX) (US-gpm at 40 psi)	Size	032 (033)
Steam nozzle	Size	- - -
Safety valve opening pressure (test manometer)	MPa (bar)	13-14,5 (130-145)
Overflow valve opening pressure (test manometer)	MPa (bar)	- - -
Work pressure full load, standard gun, new nozzle (test manometer)	MPa (bar)	9-11 (90-110)
Working pressure partial load (test manometer)	MPa (bar)	- - -
Pressure switch (ON)	MPa (bar)	< 1,5 (< 15)
Pressure switch (OFF)	MPa (bar)	13 (130)
Flow rate, full load	l/min	410 - 460
Flow rate, partial load (is generated)	l/min	- - -
Flow rate detergent, full load	l/min	0 - 0,6
Burner, water temperature increase, full load	K *	45 - 52
Burner nozzle	gph	0,55
Burner exhaust gas temperature	°C	< 200
Burner exhaust value CO ₂	%	10 - 11,5
Burner soot number	Value	0 - 1
Fuel pump, adjustment pressure	MPa (bar)	1-1,2 (10-12)
Air pressure on the burner cover	mmWS **	=/< 22
Heating oil consumption	kg/h	2,7
Heating output	kW	26
High-pressure pump oil volume	l	0,1
High-pressure pump oil type	SAE	15W40
Feed pressure water	MPa (bar)	Max. 0.6 (max. 6)
Feed volume water	l/min	min. 500
Feed temperature water	°C	max. 30
Sound	dB(A)	76
Date: March 2010		

* 1 K(elvin) = 1 °C



** 1 mmWS = 98 hPa = 98 mbar

Appliance type	Appliance no.:	Circuit diagram	operating instructions	Spare parts list
HDS 5/11 U	1.064-001	0.089-212	5.963-348	5.971-057
HDS 5/11 UX	1.064-002	0.089-212	5.963-348	5.971-057

The current technical specification sheets and circuit diagrams will be included in the next version of the spare parts CD DISIS/DISIPlus and in the kaercher-inside (<https://kaercher-inside.com>).

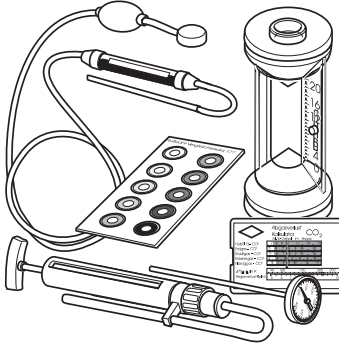
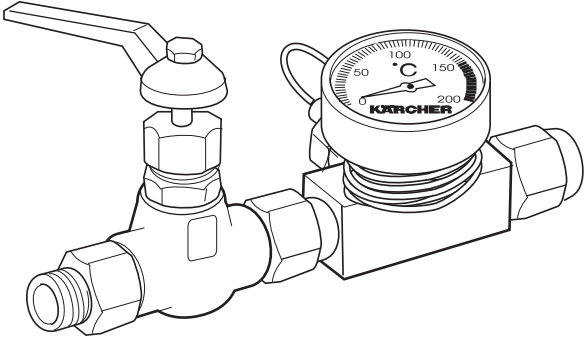
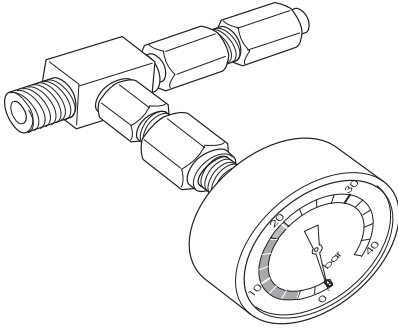
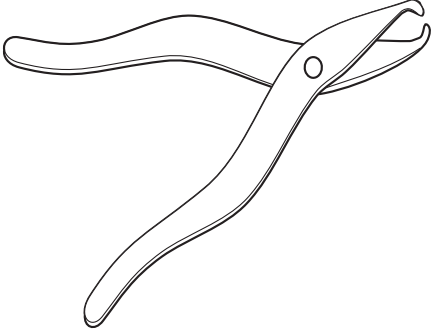
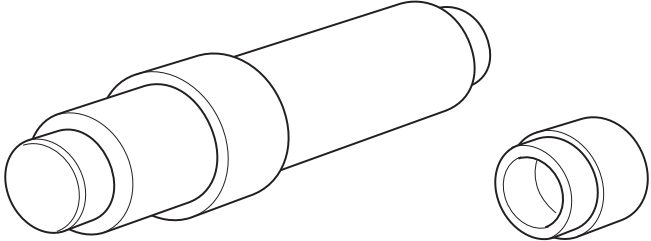
10 Special tools

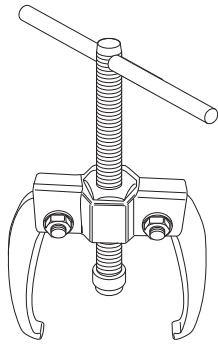
			
Electric measuring appliance	6.803-022	Exhaust measuring appliance kit	2.900-001
			
Shut-off valve with thermometer	2.901-030	Pressure gauge, fuel pressure	4.901-060
			
Removal pliers, pressure/suction valves and water sieves	4.901-062	Installation mandrel with sleeve, D = 12 mm, high pressure/oil seals	2.901-036

			
Puller tool, blower wheel	6.816-069	Adapter line (Swivel), alternative adapter hose, 0.5 m long, connection high pressure hose M22x1.5 to the safety block.	4.421-739 6.391-522
Ohne Abbildung			
Installation screws, piston guidance (2x M5x30)	6.303-098	Air pressure gauge; we recommend "Testo 510", order no. 0560 0510, hose kit, order no. 0554 0448. More information available at www.testo.com . This air pressure gauge is suitable for measurements on all HDS appliances.	Cannot be ordered from Kärcher. Please purchase externally.
Ohne Abbildung			
Pressure gauge	4.742-025		

Information about the air pressure gauge Testo 510

- Differential pressure gauge for pressure measurements in the range between 0 and 100 hPa.
- Temperature compensation
- Air tightness compensation
- Incl. hand sling and belt pouch
- Lit up display
- Selectable units: hPa, mbar, Pa, mmH₂O, mm-Hg, inH₂O, inHg, psi, m/s, fpm

- Operates on 2 AAA batteries
- Hose kit is available as accessory

11 Tightening torques

Detergent connection on the injector	Nm	12 - 15
Cylinder head screws	Nm	18 - 23
Swash plate, screw glued	Nm	12 - 15
Lock screws on holding plate of overflow unit	Nm	8 - 9
Electric box on motor	Nm	8 - 9
Safety block on cylinder head	Nm	6 - 8
Locking screw, lack of water fuse	Nm	13 - 17
Blower wheel	Nm	8 - 10
Fuel nozzle	Nm	20 - 22

12 Maintenance intervals

The maintenance intervals for these appliances are defined in the maintenance book HD/HDS appliances 5.950-582.